



Braille



# ACCESSIBILITY CHECKLIST

## WASHINGTON STATE

Northwest ADA Center  
University of Washington  
6912 220<sup>th</sup> Street SW – Suite 105  
Mountlake Terrace, WA 98043  
Toll Free (800) 949-4232  
TTD (425) 771-7426  
[www.nwadacenter.org](http://www.nwadacenter.org)

Northwest  Center



Large  
Print

CC



# ACCESSIBILITY CHECKLIST

## PURPOSE AND USE

The Northwest ADA Center is pleased to provide this Accessibility Checklist. This Checklist is designed to be a convenient tool for identifying architectural and communication barriers that may be encountered by people with disabilities in public and private buildings. The Checklist may also assist you in planning for removal of barriers to accessibility. The Checklist may be used to survey an entire facility or specific areas and elements. More definitive information may be obtained from the 2010 Standards for Accessible Design. In some situations, the 1991 Standards for Accessible Design and your state or local building code may provide helpful information. The Accessibility Checklist can also be used as a guide to increase awareness of architectural and communication barriers which prevent full access to buildings and facilities by people with disabilities. ***This checklist is NOT a substitute for federal accessibility standards or the appropriate state and local building codes.***

The Checklist is designed so that a

“**YES**” answer indicates “**ACCESSIBLE**”.

“**NO**” answer indicates that the item is present but is a “**NON-ACCESSIBLE**” feature in the building or facility.

**Dimensions** provided in this Checklist are given in units of inches (IN) or feet (FT).

### References

2010 ADA Standards for Accessible Design ([www.ada.gov](http://www.ada.gov))

1991 ADA Standards for Accessible Design ([www.ada.gov](http://www.ada.gov))

Washington State Building Code ([www.ga.wa.gov/sbcc/](http://www.ga.wa.gov/sbcc/))

**Safe Harbor** - If your facility was built or altered in the past 20 years in compliance with the 1991 Standards, or you removed barriers to specific elements in compliance with those earlier Standards, you do not have to make further modifications to those elements – even if the new standards have different requirements for them – to comply with the 2010 Standards. This provision is applied on an element-by-element basis and is referred to as the "safe harbor." If you choose to alter elements that were in compliance with the 1991 Standards, the safe harbor no longer applies to those elements and you must use the 2010 Standards. The 2010 Standards contain new requirements for elements in existing facilities that were not addressed in the original 1991 Standards. These include recreation facilities such as swimming pools, play areas, exercise machines, miniature golf facilities, and bowling alleys. Because these elements were not included in the 1991 Standards, they are not subject to the safe harbor. Therefore, on or after March 15, 2012, public accommodations or state or local government entities must remove architectural barriers to elements subject to the new requirements in the 2010 Standards when it is readily achievable to do so.

**Alternate Formats** - This Checklist will be provided in alternate formats upon request.

*Developed with support of a grant from the National Institute on Disability  
and Rehabilitation Research (NIDRR).*

*Revised Sept 2012 by Northwest ADA Center.*

*We encourage duplication and use of this document.*

# ACCESSIBILITY CHECKLIST

## TABLE OF CONTENTS

---

<b>SECTION</b>	<b>PAGE</b>
<b>Introduction / Disclaimer</b>	
<b>How to Perform an Accessibility Survey</b>	
<b>Priority 1. Parking</b>	
<i>Number of accessible spaces</i>	1
<i>Access aisles and van accessible spaces</i>	2
<i>Curb ramps</i>	3
<b>Priority 2. Accessible Approach and Entrance</b>	
<i>Surfaces and walkways</i>	4
<i>Ramps</i>	5
<i>Door width</i>	7
<i>Door handles and thresholds</i>	8
<i>Protruding objects</i>	9
<b>Priority 3. Access to Goods and Services</b>	
<i>Doors</i>	10
<i>Aisle width, reach and turning space</i>	11
<i>Table placement and height</i>	12
<i>Ramps</i>	13
<i>Elevators</i>	15
<i>Water Fountains and ATMs</i>	17
<b>Priority 4. Restrooms</b>	
<i>Entrance, turning space, mirrors and sinks</i>	18
<i>Pipes, floor space, faucets and dispensers</i>	19
<i>Toilets and grab bars</i>	20
<i>Accessible stalls and urinals</i>	21
<i>Single-User Restrooms</i>	22
<b>Additional Requirements for Hotels</b>	
<i>Accessible Guest Rooms</i>	23
<i>Dispersion</i>	24
<i>Room numbers, doors and beds</i>	25
<i>Toilets and counters</i>	27
<i>Tubs and Showers</i>	28
<i>Conference Rooms</i>	30
<i>Swimming Pools</i>	31
<i>Fitness and Laundry Rooms</i>	33
<i>Transportation, Communication, Reservations, Training</i>	34
<i>Restaurants</i>	35
<i>Retail</i>	37
<b>Notes and Sketch Page</b>	<b>A</b>
<b>Contact Information</b>	<b>B</b>

---

# HOW TO PERFORM AN ACCESSIBILITY SURVEY

## Planning for the Survey:

If possible, we suggest that a team of two or more individuals carry out the survey. It is very helpful if one person directs the process and takes notes while the other person performs the measurements. It is suggested that people with disabilities be involved in the survey.

**Using a Floor Plan:** It is often helpful to have a floor plan, or a sketch of a floor plan, for note taking while conducting the survey. Elements on this checklist can be identified on the floor plan.

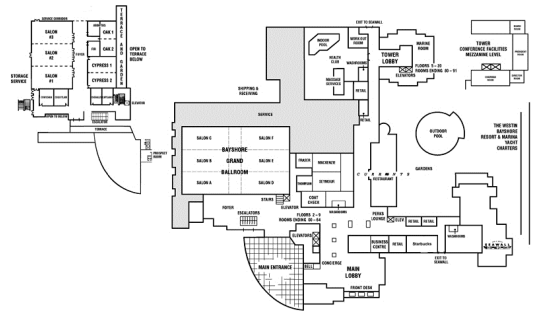

## Tools

- Clipboard to make recording on the checklist easier.
- Flexible steel tape measure.
- Carpenter's level for measuring slope on ramps and inclined walkways.
- Digital fish scale or pressure gauge for measuring door opening force.
- Digital camera for identification of barriers and accessible features. Pictures can be provided to BluePath for technical assistance and for website.



## Conducting the Survey:

**Measuring clear width (unobstructed opening)** - To measure the clear width (unobstructed open space) at a door, measure the distance between the face of the door and the edge of the door stop. Clear width measurements at other locations (ramps, accessible routes, etc.) are measured in the same manner; measure the width of the unobstructed space for passage.

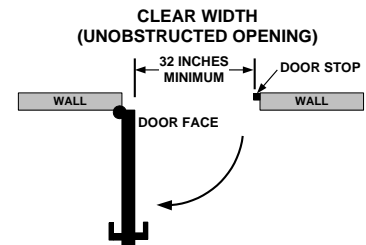

**Measuring slope** - Slope is measured by taking the ratio of vertical rise to horizontal run. For example, if a ramp 6 inches in vertical height traverses a horizontal distance of 6 feet (72 inches) then the slope is  $6 / 72 = 1 / 12 = 0.083$  (8.3%). Typically the maximum allowable slope for a ramp is written as 1:12.

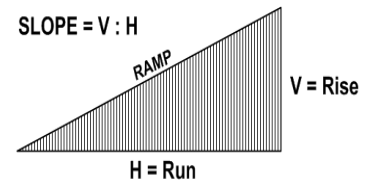

To measure the slope, lay one end of a carpenter's level on the uphill side of the ramp, lift the downhill end of the tool to bring it to level (bubble in the middle), and measure the distance between the downhill bottom edge of the level and the ramp surface. See the figure. In this case the slope is 3 inches rise over 36 inches horizontal distance or 1:12.

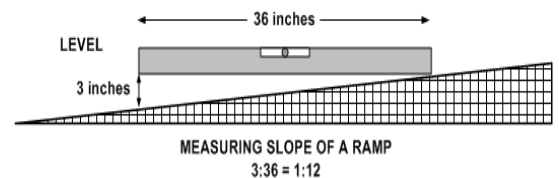

**Measuring door opening force** - If using a fish scale or similar device, tie one end of the scale to the door handle and observe the maximum force displayed on the scale as you pull the door from a closed position.

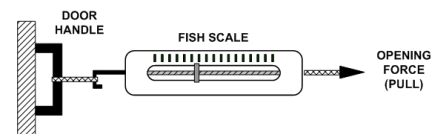

## Priority 1: PARKING

***This is the welcome sign for your business! People with disabilities should be able to arrive at your business and easily locate & use accessible parking.***

### 1. Facility Parking

Does your facility provide parking spaces designated for use by individuals with disabilities?

**Note:** This does not apply to on-street parking spaces.

**\* If your business does not provide a public parking lot, go to Priority 2 on page 4.**

- Yes  
 No  
 NAV

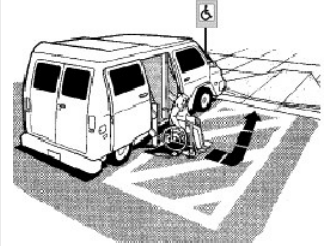

### 2. Number of Accessible Spaces

Does the parking area have the minimum number of accessible spaces specified in the table below?

Total Parking Spaces	Designated Accessible Parking
1 to 25	1
26 to 50	2
51 to 75	3
76 to 100	4
101 to 150	5
151 to 200	6
201 to 300	7
301 to 400	8
401 to 500	9
501 to 1000	2% of total
1001 and over	20 plus 1 for each 100 over 1000

**Note:** At least one of every 6 accessible parking spaces must be designated "van accessible." For example, if the facility has only one accessible parking space, then that space must be van accessible. If you have 7 accessible parking spaces then 2 must be van accessible. See Item 5 on the next page.

- Yes  
 No \*



**\* If no, how many accessible parking spaces are available?**

\_\_\_\_\_

**\* What is the total number of parking spaces available for the public?**

\_\_\_\_\_

### 3. Space Location

Are the accessible parking spaces located on the shortest possible accessible route to the building entrance?

**Note:** An accessible route is free of stairs, steep inclines, sharp changes in surface level, and has a surface which is stable, smooth and slip resistant.

Are the accessible parking spaces located on a level area?

**Note:** Surface of parking spaces and access aisles should not exceed 2% slope in any direction.

- Yes  
 No

- Yes  
 No

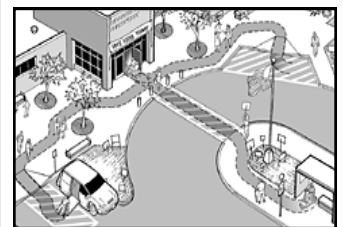

# Priority 1: PARKING

## 4. Identification and Dimensions of Car Parking Spaces

Are there signs at each accessible parking space showing the International Symbol of Accessibility posted at a height of at least 5 feet measured from the bottom edge of the sign to the ground?

If No, what are the heights? 1. \_\_\_\_\_ 2. \_\_\_\_\_ 3. \_\_\_\_\_

Are car parking spaces a minimum of 8 feet wide?

If No, what are the widths? 1. \_\_\_\_\_ 2. \_\_\_\_\_ 3. \_\_\_\_\_

Do access aisles next to the car parking spaces have a minimum width of 5 feet?

If No, what are the widths? 1. \_\_\_\_\_ 2. \_\_\_\_\_ 3. \_\_\_\_\_

**Note:** Two accessible parking spaces may share a common access aisle.

- Yes
- No



- Yes
- No
- Yes
- No

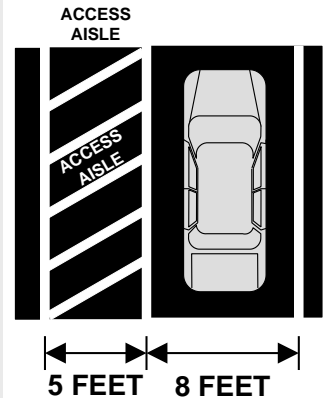

## 5. Identification and Dimensions of Van Accessible Parking Spaces

Is there at least ONE van accessible space for every SIX accessible parking spaces?

If No, how many van accessible spaces? \_\_\_\_\_

How many total accessible spaces? \_\_\_\_\_

★ **NEW - 2010 ADA Standards require one van per six accessible (as does WA state building code)**

Are the van accessible parking spaces designated by an additional sign indicating "Van Accessible"?

Do the van accessible parking spaces have a minimum vehicle area width of 8 feet (96 inches) and a minimum accompanying access aisle of at least 8 feet (96 inches)?

- OR -

...a minimum vehicle area width of 11 feet (132 inches) and an accompanying access aisle of at least 5 feet (60 inches)?

If No, what are the widths?

Parking space: \_\_\_\_\_ Access aisle: \_\_\_\_\_

- Yes
- No



- Yes
- No
- Yes
- No

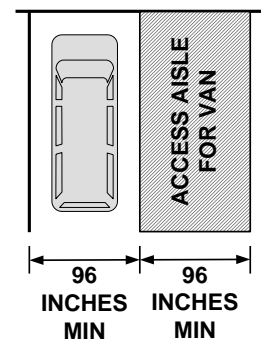

OR

- Yes
- No

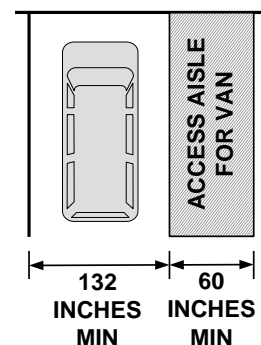

# Priority 1: PARKING

## 6. Passenger Loading Zone

If your facility has a passenger loading zone, does it have an unobstructed access aisle at least 5 feet wide and is it as long as the vehicle pull-up space?

If No, what is the width? \_\_\_\_\_ and length? \_\_\_\_\_

**Note:** The vehicle pull-up space must be a minimum of 8 feet wide and 20 feet long.

Is the access aisle at the same level as the vehicle pull-up space?

Is the access aisle marked to discourage parking in that space?

- Yes
- No
- NAV

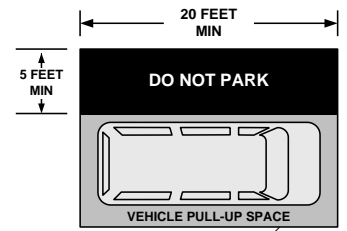

- Yes
- No
- Yes
- No

## 7. Curb Ramps

Are curb ramps provided where accessible routes cross over a curb?

**Note:** Curb ramps must not project into traffic lanes, parking spaces or access aisles.

Do curb ramps have a maximum running slope of 1:12?

If No, what are the slopes? 1. \_\_\_\_\_ 2. \_\_\_\_\_ 3. \_\_\_\_\_

Do curb ramps have a minimum clear width of 36 inches?

If No, what are the widths? 1. \_\_\_\_\_ 2. \_\_\_\_\_ 3. \_\_\_\_\_

Are the transition areas where curb ramps join sidewalks, streets or gutters smooth?

Are there level landings at the top of the curb ramps which have a minimum length of 36 inches and the same width as the curb ramp?

If No, what are the lengths? 1. \_\_\_\_\_ 2. \_\_\_\_\_ 3. \_\_\_\_\_

**Note:** Where it is not possible to provide a level landing at the top of a curb ramp, a curb ramp with flared sides that do not exceed a slope of 1:12 is an alternative.

- Yes
- No
- NAV

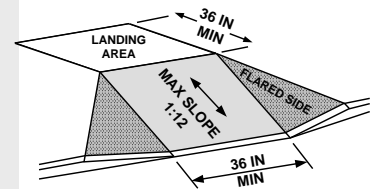

- Yes
- No
- Yes
- No
- Yes
- No

## Priority 2: ACCESSIBLE APPROACH AND ENTRANCE (Exterior Routes)

**People with disabilities should be able to arrive at the site, approach the building and enter the building as freely as everyone else. At least one accessible route should be safe and accessible for everyone.**

### 1. Ground and Floor Surfaces

Are ground, floor and walking surfaces along accessible routes stable, firm, smooth and slip-resistant?

**Note:** An “accessible route” may consist of doorways, ramps, curb ramps, elevators, platform lifts and other walking surfaces with a slope no steeper than 5% (1:20).

- Yes  
 No



### 2. Changes in Surface Level

Are all ground and floor surfaces along accessible routes free of abrupt level changes? Surface level changes cannot exceed 1/4 inch in height.

Where vertical elevation changes are between 1/4 and 1/2 inches in height, is the level change beveled?

**Note:** Anything more than a 1/2 inch is considered a ramp.

Are ramps provided for changes in surface level which exceed 1/2 inch in height? (See ramp requirements on pages 5 and 6).

- Yes  
 No  
 Yes  
 No  
 NAV

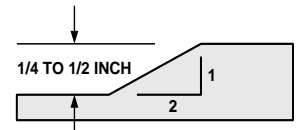

- Yes  
 No  
 NAV

### 3. Clear Widths and Slopes for Walkways

Is there at least one accessible route from the accessible parking areas or passenger loading zones to the accessible building entrance?

Do all walkways along accessible routes have a minimum clear, unobstructed width of at least 36 inches?

If No, what is the minimum clear width? \_\_\_\_\_

Do longer routes have an occasional 5 x 5 feet area located at reasonable intervals not exceeding 200 feet which can be used for turning and passing?

Do all walkways along accessible routes have cross slopes that are 1:48 or less?

**Note:** When the running slope along the direction of travel on an accessible route is greater than 1:20 (5%) the route is considered a “ramp”. See Items 4-8 on the next two pages.

- Yes  
 No  
 NAV

- Yes  
 No

- Yes  
 No

- Yes  
 No

MEASURING CLEAR WIDTH OF AN ACCESSIBLE ROUTE IN PRESENCE OF OBSTRUCTIONS

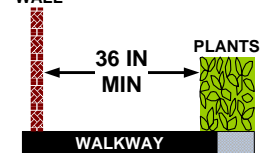

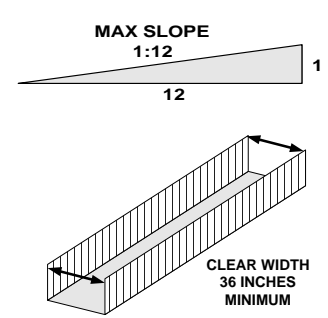
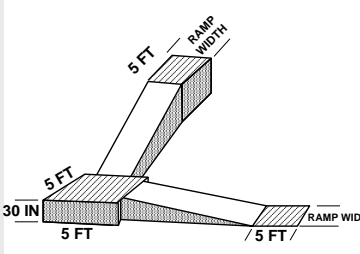
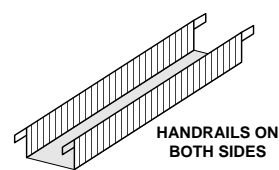
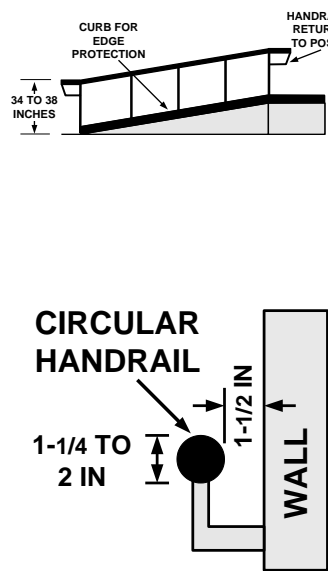

## Priority 2: ACCESSIBLE APPROACH AND ENTRANCE (Exterior Routes)

<p><b>IS THERE A RAMP LOCATED ON THE EXTERIOR OF YOUR BUSINESS SITE?</b></p>	<p><input type="checkbox"/> Yes <input type="checkbox"/> No</p>	<p><b>IF NO, SKIP TO #9.</b></p>
<p><b>4. Ramp Slope and Clear Width</b></p> <p>Is the maximum slope of all ramps 1:12 (8.3%)? If No, what is the slope? _____</p> <p><b>Note:</b> A 1:12 slope is 1 inch of vertical rise to every 12 inches of horizontal distance.</p> <p>Does the ramp have a clear unobstructed width of at least 36 inches? If No, what is the clear width of the ramp? _____</p>	<p><input type="checkbox"/> Yes <input type="checkbox"/> No</p> <p><input type="checkbox"/> Yes <input type="checkbox"/> No</p>	 <p>MAX SLOPE 1:12</p> <p>CLEAR WIDTH 36 INCHES MINIMUM</p>
<p><b>5. Landings</b></p> <p>Do ramps have a 5 foot long level landing at the top and bottom of each run? If No, how long is the landing? _____</p> <p>Do ramps have a 5 x 5 foot minimum turning space at level landings where the ramp changes direction? If No, what are the dimensions of the landings? _____ x _____</p> <p><b>Note:</b> Landings are required where the maximum vertical rise for any length of run for a ramp is 30 inches.</p>	<p><input type="checkbox"/> Yes <input type="checkbox"/> No</p> <p><input type="checkbox"/> Yes <input type="checkbox"/> No <input type="checkbox"/> NAV</p>	 <p>5 FT RAMP WIDTH</p> <p>5 FT RAMP WIDTH</p> <p>30 IN 5 FT</p>
<p><b>6. Ramp Handrails</b></p> <p>If the ramp rises more than 6 inches, does it have handrails on both sides?</p>	<p><input type="checkbox"/> Yes <input type="checkbox"/> No <input type="checkbox"/> NAV</p>	 <p>HANDRAILS ON BOTH SIDES</p>
<p><b>7. Handrail Location</b></p> <p><i>(Skip if previous question was NAV)</i></p> <p>Are handrails mounted so that their top surface is between 34 and 38 inches above the ramp surface? If No, what is the height of the top of the handrails? _____</p> <p>Do handrails continue to extend horizontally at least 12 inches at the top and bottom landings of the ramp and do these extensions return to the wall, floor or post?</p> <p>If the handrail is mounted on the wall, is the gap between the handrail and the wall exactly 1-1/2 inches? If No, what is the width of the gap? _____</p> <p>If the handrail is circular in shape, is the diameter 1 1/4 inches minimum to 2 inches maximum?</p> <p>If the shape is non-circular, is the diameter no more than 2 1/4 inches maximum?</p>	<p><input type="checkbox"/> Yes <input type="checkbox"/> No</p> <p><input type="checkbox"/> Yes <input type="checkbox"/> No</p> <p><input type="checkbox"/> Yes <input type="checkbox"/> No <input type="checkbox"/> NAV</p> <p><input type="checkbox"/> Yes <input type="checkbox"/> No</p> <p><input type="checkbox"/> Yes <input type="checkbox"/> No</p>	 <p>CURB FOR EDGE PROTECTION</p> <p>HANDRAIL RETURN TO POST</p> <p>34 TO 38 INCHES</p> <p>CIRCULAR HANDRAIL</p> <p>1-1/4 TO 2 IN</p> <p>1-1/2 IN</p> <p>WALL</p>

## Priority 2: ACCESSIBLE APPROACH AND ENTRANCE (Exterior Routes)

### 8. Protective Edges on Ramps

Do ramps and landings have edge protection?

- Yes  
 No

**Note:** Edge protection can be provided by:

1. By extending the floor surface of a ramp or landing at least 12 inches beyond the railing, or,
2. A curb or barrier that prevents passage of a crutch, a wheel on a wheelchair or other mobility aid from going over the edge of the ramp or landing.

Examples are:

- a. curbs at least 4 inches high,
- b. horizontal rails placed no more than 4 inches from the floor or wall
- c. vertical railing spaced less than 4 inches apart can be used to prevent wheels on wheelchairs and other mobility aids from going off the edge of the ramp.

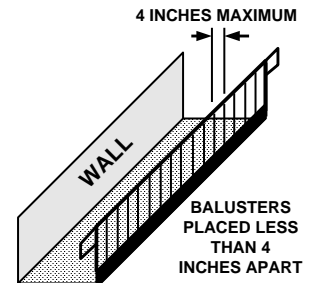
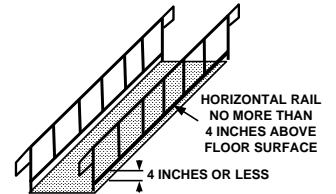
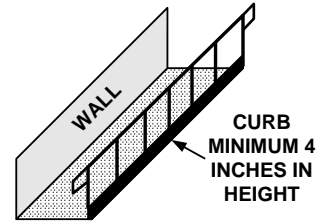

## Priority 2: ACCESSIBLE APPROACH AND ENTRANCE (Exterior Routes)

### 9. Doorway Width and Maneuvering Clearance

Is there a minimum of 60 x 60 inches of level landing space centered at the front of the accessible entrance?

If No, what are the dimensions of the landing? \_\_\_\_\_

Do accessible entrances have a minimum clear opening (free of protrusions and obstructions) of 32 inches?

If No, what are the widths of the clear openings at entrances?

1. \_\_\_\_\_ 2. \_\_\_\_\_ 3. \_\_\_\_\_

Do the push or pull sides of doors have adequate clearance from the side and front of the doorway to allow customer to reach handle and maneuver around and through the door opening?

If No, what are the side and front (approach) distances? Side: \_\_\_\_\_ Front: \_\_\_\_\_

**Note:** If the person using a wheelchair can approach the door from the front, a minimum side distance of 18 inches and a minimum perpendicular distance of 60 inches will suffice if the door swings toward the customer (shown in top figure).

**Note:** A minimum of 12 inches side distance and a minimum perpendicular distance of 48 inches is required for a door that swings away from the customer and has a latch and closer (shown in bottom figure).

**Note:** Automatic or power assisted doors do not typically require these types of maneuvering clearances adjacent to the doors.

Yes

No

Yes

No

Yes

No

NAV

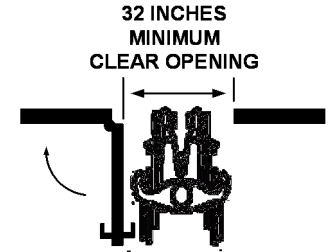

MANEUVERING CLEARANCE AT DOOR  
FRONT APPROACH TO PULL FACE OF DOOR

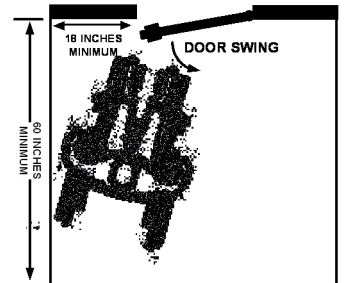

MANEUVERING CLEARANCE AT DOOR  
FRONT APPROACH TO PUSH FACE OF DOOR  
WITH A CLOSER AND LATCH

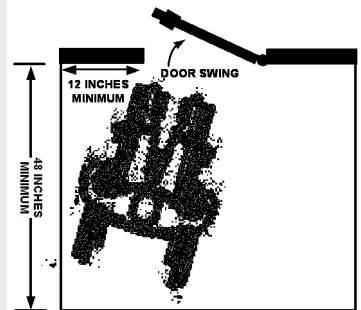

### 10. Door Opening Force

Is the force required to open accessible exterior entrances no more than 10 pounds?

If No, what is the opening force? \_\_\_\_\_

Yes

No

NAV

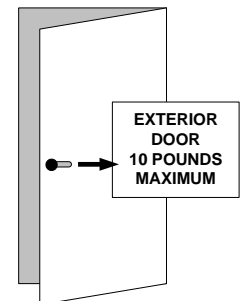

## Priority 2: ACCESSIBLE APPROACH AND ENTRANCE (Exterior Routes)

### 11. Door Hardware

Are handles, pulls, latches, locks, and other operating devices on accessible doors easily grasped with one hand, and require no tight grasping, pinching, or twisting of the wrist to operate?

**Note:** Lever and loop handles serve this purpose well.

Are door handles mounted no higher than 48 inches and no lower than 34 inches from the floor surface?

- Yes
- No
- NAV

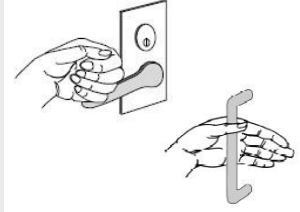

- Yes
- No

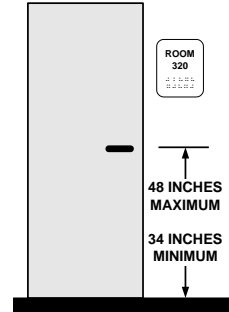

### 12. Doors in Series

If two doors in a series swing in the same direction (see top figure), is the distance between the walls (door surfaces when closed) at least 48 inches plus the width of the in-swinging door?  
If No, what is this distance? \_\_\_\_\_

If two doors in series swing in opposite directions (see bottom figure) is the distance between the walls (door surfaces when closed) at least 48 inches?  
If No, what is this distance? \_\_\_\_\_

- Yes
- No
- NAV

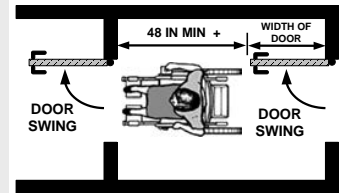

- Yes
- No
- NAV

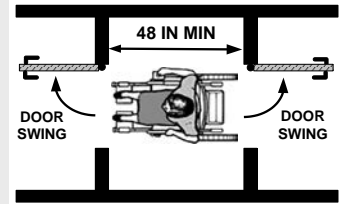

### 13. Thresholds

Are the heights of all thresholds 1/2 inch or less?

If No, what are the heights? 1. \_\_\_\_\_ 2. \_\_\_\_\_ 3. \_\_\_\_\_

**Note:** Any threshold between 1/2 inch and 3/4 inches must be beveled.

- Yes
- No
- NAV

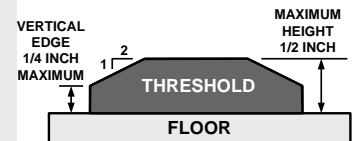

## Priority 2: ACCESSIBLE APPROACH AND ENTRANCE (Exterior Routes)

### 14. Protruding Objects

Do protruding and hanging objects with a leading edge more than 27 inches above the floor, protrude no more than 4 inches into the path of travel?

If No, how far do the objects protrude? \_\_\_\_\_

**Note:** Examples include telephones, water fountains, signs, planters, lamps, etc.

Do walks, halls, corridors, passageways, aisles or other circulation spaces have a minimum head clearance of 80 inches?

If No, how far is the overhead object from floor level? \_\_\_\_\_

Yes

No

Yes

No

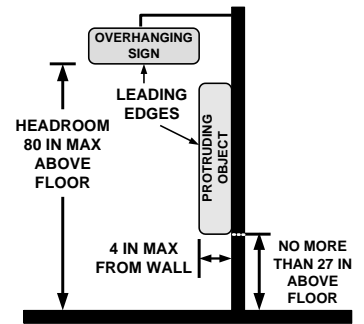

### 15. Suspended Stairs

Are all suspended stairs or other overhead obstructions provide sufficient warning devices, for example, railings, planters, etc., to alert people who are visually impaired?

Yes

No

NAV

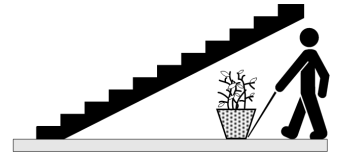

# Priority 3: ACCESS TO GOODS AND SERVICES (Interior Routes and Spaces)

## 1. Doors in Public Spaces

Do the interior doors in public spaces have at least a 32-inch clear, unobstructed opening?

If No, what are the opening widths of the doors?

1. \_\_\_\_\_ 2. \_\_\_\_\_ 3. \_\_\_\_\_

**Note:** With double doors, at least one door must have a minimum clear opening of 32 inches.

- Yes
- No
- NAV

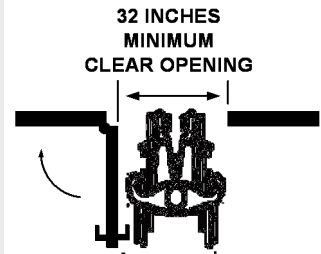

## 2. Maneuvering Clearance

Do the pull and push sides of doors have adequate maneuvering clearances in front of and to the sides of doorways so that a person using a wheelchair can position themselves to open the door?

(See Priority 2, Item 9 on page 7 for more information)

If No, what are the side and front (approach) distances? Side: \_\_\_\_\_ Front: \_\_\_\_\_

- Yes
- No
- NAV

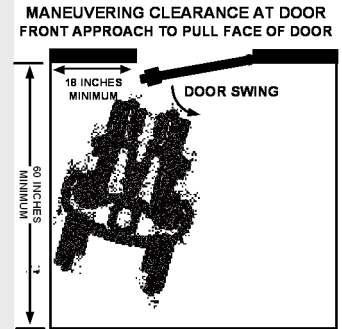

## 3. Signs for Permanent Rooms and Spaces

Are signs designating permanent rooms and spaces, such as restrooms or conference rooms, designed to have good contrast (very dark and very light) between characters and background, adequate character size for viewing distance, raised (tactile) characters and Braille?

Are signs mounted so that the tactile characters are between 48 to 60 inches from the floor surface?

If No, what are the heights?

Max: \_\_\_\_\_ Min: \_\_\_\_\_

★ **NEW 2010 Standards effective when you remodel:**

Signs must be mounted so the bottom edge of the *highest* tactile characters is 60 inches max above the floor and the *lowest* tactile characters are 48 inches minimum from the floor.

- Yes
- No
- NAV
  
- Yes
- No

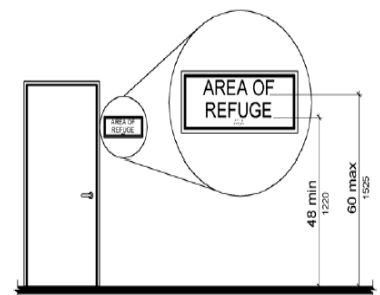

## 4. Door Opening Force

Can interior doors be opened with 5 lb or less force?

If No, what is the force required to open the doors?

1. \_\_\_\_\_ 2. \_\_\_\_\_ 3. \_\_\_\_\_

- Yes
- No
- NAV

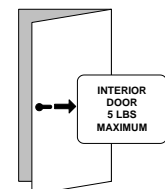

## 5. Door Handle Height

Are door handles mounted no higher than 48 inches and no lower than 34 inches from the floor surface?

If No, what is the height? 1. \_\_\_\_\_ 2. \_\_\_\_\_ 3. \_\_\_\_\_

- Yes
- No
- NAV

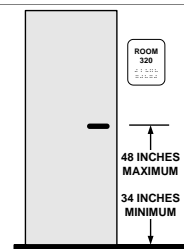

# Priority 3: ACCESS TO GOODS AND SERVICES (Interior Routes and Spaces)

## 6. Door Hardware

Do all latch doors along an accessible route have a handle that does not require tight grasping, pinching, or twisting to operate?

If there is no latch, do the doors have pulls, loops or push plates?

- Yes
- No
- NAV
- Yes
- No
- NAV

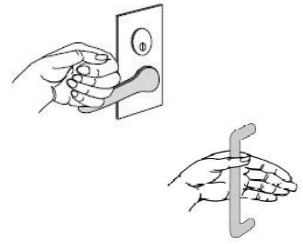

## 7. Thresholds

Are the heights of all thresholds 1/2 inch or less?

If No, what are the heights? 1. \_\_\_\_\_ 2. \_\_\_\_\_ 3. \_\_\_\_\_

**Note:** Any threshold between 1/2 inch and 3/4 inches must be beveled.

- Yes
- No
- NAV

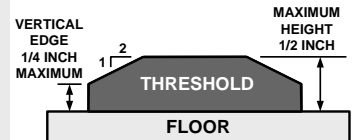

## 8. Aisle Width and Reach to Products

Do all aisles and pathways to goods and services have a minimum clear, unobstructed passage width of 36 inches?

If No, what are these minimum passage widths?  
1. \_\_\_\_\_ 2. \_\_\_\_\_ 3. \_\_\_\_\_

If products or goods are available, are they within reach?

**Note:** For a forward reach, the maximum height is 48 inches and the minimum low distance from the floor is 15 inches.

For a side reach, the maximum height is 54 inches and the minimum height should be 9 inches.

If No, what are the maximum and minimum heights?

Forward (Max) 1. \_\_\_\_\_ 2. \_\_\_\_\_ 3. \_\_\_\_\_ (Min) 1. \_\_\_\_\_ 2. \_\_\_\_\_ 3. \_\_\_\_\_

Side (Max) 1. \_\_\_\_\_ 2. \_\_\_\_\_ 3. \_\_\_\_\_ (Min) 1. \_\_\_\_\_ 2. \_\_\_\_\_ 3. \_\_\_\_\_

★ **NEW 2010 Standards effective when you remodel:**

Both forward AND side reach ranges will be 48 inches maximum and 15 inches minimum heights.

- Yes
- No
- Yes
- No
- NAV

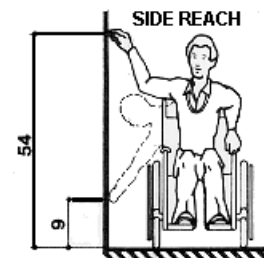
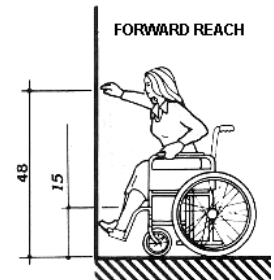

## 9. Turning Space

Is there adequate turning space for a wheelchair or other mobility device?

**Note:** A turning space may have:

1. A minimum diameter of 60 inches (top figure), or,
2. T-shaped space where the width is not less than 36 inches (bottom figure).

If No, what are the turning diameters or widths of the spaces available?

1. \_\_\_\_\_ 2. \_\_\_\_\_ 3. \_\_\_\_\_

- Yes
- No

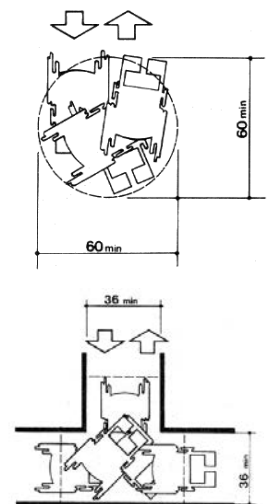

## Priority 3: ACCESS TO GOODS AND SERVICES (Interior Routes and Spaces)

If Items 10-11 can only apply to tables in a restaurant, skip to Item 12 and complete the Restaurant section on pg. 34-35.

### 10. Table Placement and Seating Distribution

If tables or work surfaces are available, is there a 36 inch aisle clearance and a 30 inch wide space at the tables or work surfaces for wheelchair access?

If No, what are the widths of the aisle clearances?

1. \_\_\_\_\_ 2. \_\_\_\_\_ 3. \_\_\_\_\_

Are seating spaces for wheelchairs distributed throughout?

**Note:** People should be able to choose the locations and types of tables, seating and other furnishings.

Do seating spaces at tables allow for a forward approach and provide a clear floor space of 30 by 48 inches?

- Yes
  - No
  - NAV
- If NAV, skip to 12

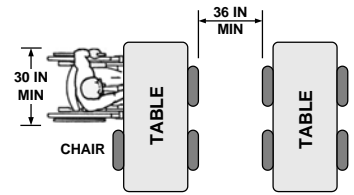

- Yes
- No
- Yes
- No

MINIMUM CLEAR FLOOR SPACE SEATING AND TABLES

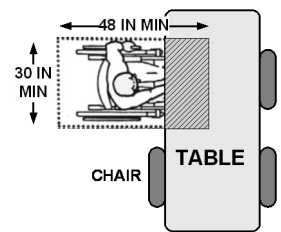

### 11. Table Height and Legroom

Does the space under MOST tables have legroom (clear opening for knee space) of at least 27 inches in height, 30 inches in width, and 17 inches in depth?

If No, what are the dimensions available for leg clearance?

H: \_\_\_\_\_ W: \_\_\_\_\_ D: \_\_\_\_\_

Is the top surface of the table 28 inches minimum to 34 inches in maximum height?

If No, what is the table top height? \_\_\_\_\_

- Yes
- No
- Yes
- No

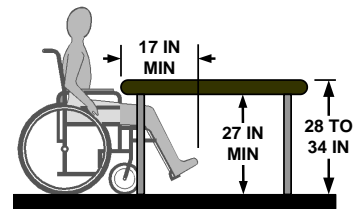

### 12. Protruding Objects on the Interior of Your Facility

Do protruding and hanging objects with a leading edge more than 27 inches above the floor, protrude no more than 4 inches into the path of travel?

If No, how far do the objects protrude? \_\_\_\_\_

Do walks, halls, corridors, passageways, aisles or other circulation spaces have a minimum head clearance of 80 inches?

If No, how far is the overhead object from floor level? \_\_\_\_\_

- Yes
- No
- NAV
- Yes
- No

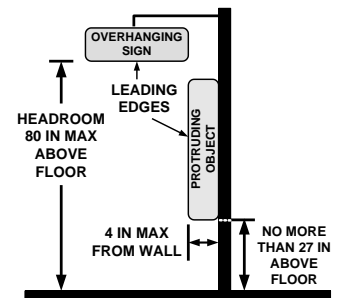

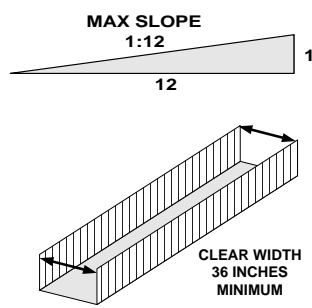
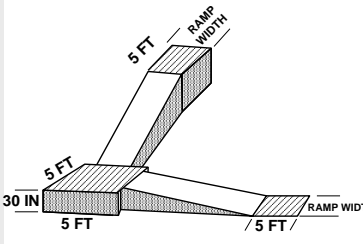
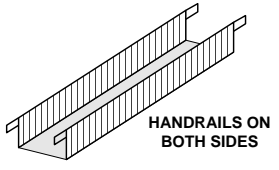
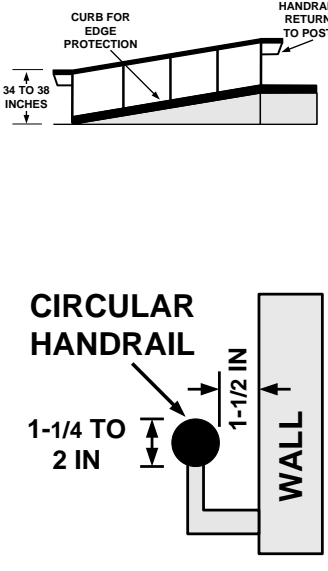

## Priority 3: ACCESS TO GOODS AND SERVICES (Interior Routes and Spaces)

<p><b>IS THERE A RAMP LOCATED ON THE INTERIOR OF YOUR BUSINESS SITE?</b></p>	<p><input type="checkbox"/> Yes <input type="checkbox"/> No</p>	<p><b>IF NO, SKIP TO #18.</b></p>
<p><b>13. Ramp Slope and Clear Width</b></p> <p>Is the maximum slope of all ramps 1:12 (8.3%)? If No, what is the slope? _____</p> <p><b>Note:</b> A 1:12 slope is 1 inch of vertical rise to every 12 inches of horizontal distance.</p> <p>Does the ramp have a clear unobstructed width of at least 36 inches? If No, what is the clear width of the ramp? _____</p>	<p><input type="checkbox"/> Yes <input type="checkbox"/> No</p> <p><input type="checkbox"/> Yes <input type="checkbox"/> No</p>	 <p>MAX SLOPE 1:12</p> <p>CLEAR WIDTH 36 INCHES MINIMUM</p>
<p><b>14. Landings</b></p> <p>Do ramps have a 5 foot long level landing at the top and bottom of each run? If No, how long is the landing? _____</p> <p>Do ramps have a 60 x 60 inch minimum turning space at level landings where the ramp changes direction? If No, what are the dimensions of the landings? _____ x _____</p> <p><b>Note:</b> Landings are required where the maximum vertical rise for any length of run for a ramp is 30 inches.</p>	<p><input type="checkbox"/> Yes <input type="checkbox"/> No</p> <p><input type="checkbox"/> Yes <input type="checkbox"/> No <input type="checkbox"/> NAV</p>	 <p>5 FT RAMP WIDTH</p> <p>5 FT 5 FT RAMP WIDTH</p> <p>30 IN</p>
<p><b>15. Ramp Handrails</b></p> <p>If the ramp rises more than 6 inches, does it have handrails on both sides?</p>	<p><input type="checkbox"/> Yes <input type="checkbox"/> No <input type="checkbox"/> NAV</p>	 <p>HANDRAILS ON BOTH SIDES</p>
<p><b>16. Handrail Location</b></p> <p><i>(Skip if previous question was NAV)</i></p> <p>Are handrails mounted so that their top surface is between 34 and 38 inches above the ramp surface? If No, what is the height of the top of the handrails? _____</p> <p>Do handrails continue to extend horizontally at least 12 inches at the top and bottom landings of the ramp and do these extensions return to the wall, floor or post?</p> <p>If the handrail is mounted on the wall, is the gap between the handrail and the wall exactly 1-1/2 inches? If No, what is the width of the gap? _____</p> <p>If the handrail is circular in shape, is the diameter 1-1/4 inches minimum to 2 inches maximum?</p> <p>If the shape is non-circular, is the diameter no more than 2 1/4 inches maximum?</p>	<p><input type="checkbox"/> Yes <input type="checkbox"/> No</p> <p><input type="checkbox"/> Yes <input type="checkbox"/> No</p> <p><input type="checkbox"/> Yes <input type="checkbox"/> No</p> <p><input type="checkbox"/> Yes <input type="checkbox"/> No</p> <p><input type="checkbox"/> Yes <input type="checkbox"/> No</p>	 <p>CURB FOR EDGE PROTECTION</p> <p>HANDRAIL RETURN TO POST</p> <p>34 TO 38 INCHES</p> <p>CIRCULAR HANDRAIL</p> <p>1-1/2 IN</p> <p>1-1/4 TO 2 IN</p> <p>WALL</p>

## Priority 3: ACCESS TO GOODS AND SERVICES (Interior Routes and Spaces)

### 17. Protective Edges on Ramps

Do ramps and landings have edge protection?

- Yes  
 No

**Note:** Edge protection can be provided by:

1. By extending the floor surface of a ramp or landing at least 12 inches beyond the railing, or,
2. A curb or barrier that prevents passage of a crutch, a wheel on a wheelchair or other mobility aid from going over the edge of the ramp or landing.

Examples are:

- a. curbs at least 4 inches high,
- b. horizontal rails placed no more than 4 inches from the floor or wall
- c. vertical railing spaced less than 4 inches apart can be used to prevent wheels on wheelchairs and other mobility aids from going off the edge of the ramp.

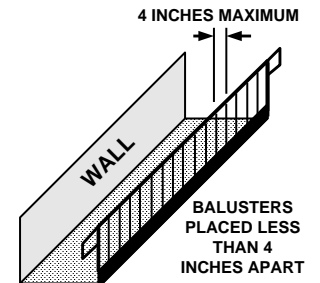
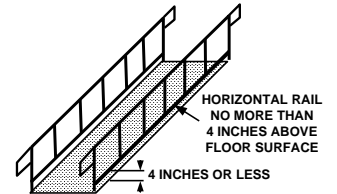
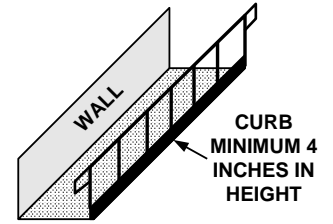

## Priority 3: ACCESS TO GOODS AND SERVICES (Interior Routes and Spaces)

**DOES THE FACILITY HAVE A PASSENGER ELEVATOR?**

- Yes  
 No

**IF NO...  
 SKIP TO #26.**

### 18. Hall Call Buttons and Entrance Labels

Are call buttons in lobbies and halls mounted no higher than 54 inches when measured to centerline of highest operable part above the floor?

If No, what is the height? \_\_\_\_\_

Are there raised (tactile) characters and Braille to indicate floor destinations on both elevator jamba 60 inches above the floor surface?

- Yes  
 No

- Yes  
 No

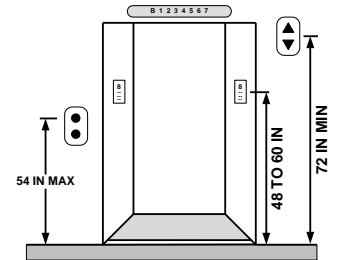

### 19. Signal Identification

Are there both visual and audible signals to identify when an elevator car arrives and its direction of travel?

Visual lights and/or numbers:

Audible Sounds:

*For example, indicator sounds once for up and twice for down*

- Yes  
 No

- Yes  
 No

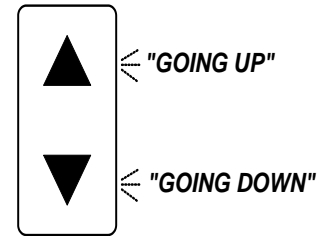

### 20. Elevator Car Dimensions

Do elevators have minimum inside dimensions of 51 inches in depth by 80 inches in width and a clear door opening of 42 inches?

If No, what is the depth, width, and clear door opening?

D: \_\_\_\_\_ W: \_\_\_\_\_ O: \_\_\_\_\_

- Yes  
 No

**Note: alternate dimensions might be acceptable...**

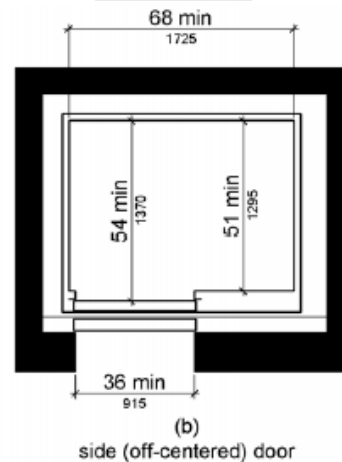
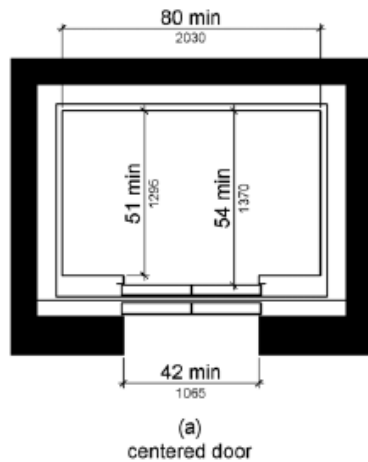

## Priority 3: ACCESS TO GOODS AND SERVICES (Interior Routes and Spaces)

### 21. Leveling

Does the elevator stop within 1/2 inch of the outside floor surface on each level?

- Yes  
 No

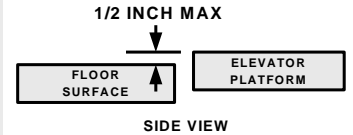

### 22. Gap Between Elevator and Floor

Is the open space between the outside floor surface and the elevator platform no greater than 1-1/4 inches?

- Yes  
 No

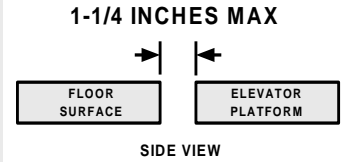

### 23. Protective Re-Opening Device

Are the elevators equipped with door protection and reopening devices that automatically opens the door when it becomes obstructed or contacted by an object or person?

- Yes  
 No

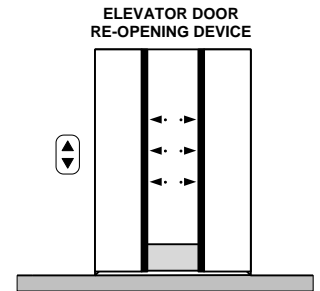

### 24. Car Controls and Position Indicators

Are car controls, call buttons, and alarm buttons at least 3/4 inch in diameter with Braille and raised lettering?

- Yes  
 No

Are all controls or buttons on the inside elevator control panel mounted no higher than 48 inches above the floor?

If No, what is the distance from the elevator floor to the highest control? \_\_\_\_\_

- Yes  
 No

Are emergency control buttons mounted at 35 inches minimum height above the floor?

- Yes  
 No

Are visual and audible prompts provided in the interior of the car to indicate car position? (floor/level)

Visual:  Yes

- No

Audible:  Yes

- No

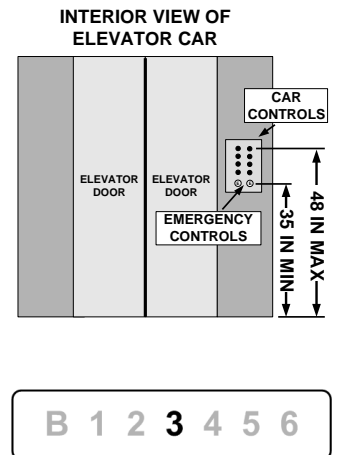

### 25. Emergency Communications

Are emergency two-way communication systems provided between the inside of the elevator and a monitored point outside?

- Yes  
 No

Is the highest operable part located no higher than 48 inches?

- Yes  
 No

Are tactile symbols AND characters provided on or next to the device?

- Yes  
 No



## Priority 3: ACCESS TO GOODS AND SERVICES (Interior Routes and Spaces)

### 26. Water Fountains

Is there at least one wheelchair accessible water fountain available that is mounted to provide a minimum clearance of 27 inches and a maximum depth of 19 inches so that it can be approached and used by a person in a wheelchair?

- Yes
- No
- NAV

Is there an accessible route leading to the water fountain with a 30 x 48 inch clear floor space under or next to the fountain?

- Yes
- No

Is the maximum height of the spout 36 inches or less from the floor?

- Yes
- No

If the water fountain is installed in an alcove more than 8 inches deep, is the width of the alcove at least 30 inches?

- Yes
- No
- NAV

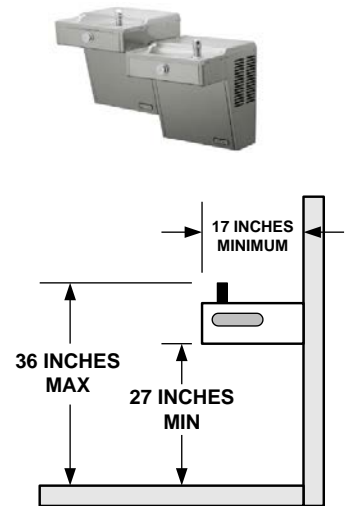

### 27. Automated Teller Machines (ATM)

Is there sufficient clear floor space (30 x 48 inches) adjacent to the ATM to allow for forward or parallel approach by a wheelchair?

- NAV

Is the maximum height of all operable controls or buttons 48 inches for a front approach or for a parallel approach by a wheelchair?

- Yes
- No

Are instructions and information for use of the ATM accessible to persons with visual impairments?

- Yes
- No

**Note:** Function keys should contrast visually from background and machine must be “speech-enabled” and have Braille instructions for speech mode, input for headphones, etc.

**If ATM does not meet these standards, contact the associated vendor.**



## Priority 4: PUBLIC RESTROOMS

*If your facility has public restrooms, at least one for each gender or one unisex (single-user) must be accessible.*

Does your facility offer restrooms to the public?  Yes  No

Note: M = Men's W = Women's

If no, skip all of Priority 4.

### 1. Restroom Identification

Are the accessible restrooms clearly marked with a sign of the International Symbol of Accessibility and mounted so the bottom edge of the *highest* tactile characters are 60 inches maximum above the floor and the *lowest* tactile characters are 48 inches minimum from the floor?

If No, what are the heights? M: \_\_\_\_\_ W: \_\_\_\_\_

Do the signs identifying the accessible restrooms have raised (tactile) and Braille characters?

- Yes  
 No  
 Yes  
 No

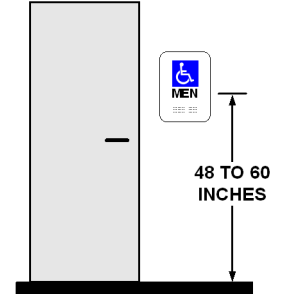

### 2. Restroom Entrances

Do accessible restroom entrances have a clear opening of 32 inches and maneuvering clearance adjacent to both sides of the doors which conforms to Priority 2, Item 9 on page 8?

If No, what are the clear openings? M: \_\_\_\_\_ W: \_\_\_\_\_

- Yes  
 No

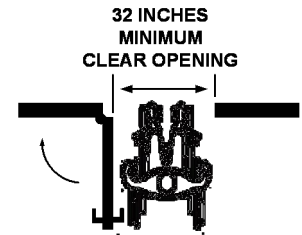

### 3. Turning Space

Is there adequate turning space for a wheelchair or other mobility device inside the restroom?

**Note:** A turning space may have a minimum diameter of 60 inches or a T-shaped space where the width is not less than 36 inches. See Priority 3, Item 9 on page 11.

If No, what are the turning diameters or widths of the \_\_\_\_\_ spaces available?

M: \_\_\_\_\_ W: \_\_\_\_\_

- Yes  
 No

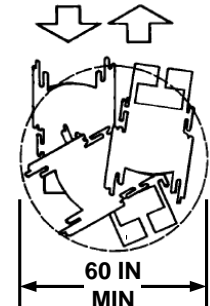

### 4. Sink Heights

Is there at least one sink mounted so that the counter surface is no higher than 34 inches above the floor?

Is the knee clearance space at least 27 inches from the bottom of sink aprons to the floor?

Are drain pipes mounted so that there is at least 9 inches of toe clearance from the floor surface?

If No to any of the above, what are the measurements?

top surface height: \_\_\_\_\_  
 bottom surface height: \_\_\_\_\_  
 Toe clearance below pipe: \_\_\_\_\_

- Yes  
 No  
 Yes  
 No  
 Yes  
 No  
 NAV

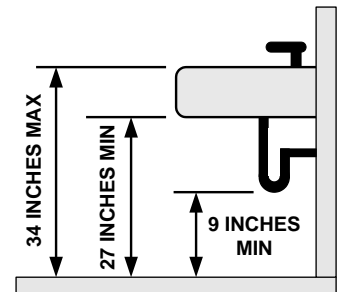

- There is no clearance under the sink.

Skip to Item 6.

## Priority 4: PUBLIC RESTROOMS

### 5. Protective Pipe Covering

Is insulation or other protective covering used on exposed hot water and drain pipes under the sinks?

- Yes  
 No  
 NAV

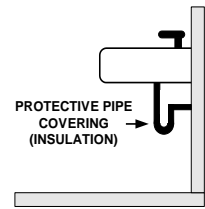

### 6. Sink Clear Floor Space

Is there clear floor space (30 x 48 inches) provided in front of sinks to allow for forward approach?

- Yes  
 No

**Note:** A maximum of 19 inches out of the required 48 inches of clear floor space can be under the sink.

If No, what are the dimensions of the clear space?

M: \_\_\_\_\_ W: \_\_\_\_\_

Is the total depth of knee and toe clearance beneath sinks at least 17 inches?

- Yes  
 No

**Note:** 17 inches allows for a combination of 11 inches of knee space (to the drain pipe for example) and an additional 6 inches for toe space (below pipe) to the wall.

If No, what is the knee and toe clearance?

M: (knee) \_\_\_\_\_ (toe) \_\_\_\_\_ W: (knee) \_\_\_\_\_ (toe) \_\_\_\_\_

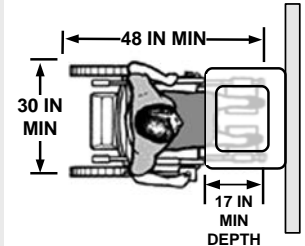

### 7. Faucet Controls

At accessible sinks, are the faucets controlled by a hand lever, push button, or electronic control that is easily operated by one hand, not requiring tight grasping, pinching, or twisting?

- Yes  
 No  
 NAV

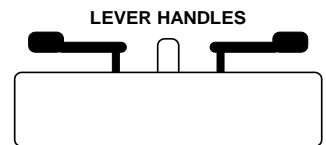

If No, what is the distance? M: \_\_\_\_\_ W: \_\_\_\_\_

- Yes  
 No

### 8. Restroom Mirror

Does each accessible restroom have at least one mirror mounted 40 inches from the floor to the bottom edge of the reflective surface?

If No, what are the heights? M: \_\_\_\_\_ W: \_\_\_\_\_

- Yes  
 No  
 NAV

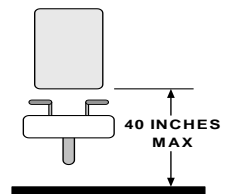

### 9. Dispensers in Restroom

Are the soap/towel dispensers and other accessories mounted so that there is no more than 48 inches to the highest control or operable part?

★ **NEW 2010 Standards effective when you remodel:**

Dispensers that were mounted at 54 inches for a side approach will need to be lowered to 48 inches.

- Yes  
 No

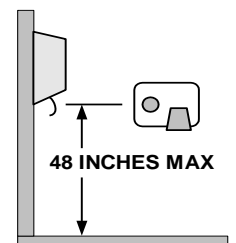

## Priority 4: PUBLIC RESTROOMS

### 10. Toilet Seat Height and Distance from Wall

Is the top of the accessible toilet seat 17 to 19 inches from the surface of the floor?

If No, how high is the toilet seat? M: \_\_\_\_\_ W: \_\_\_\_\_

Is the center of the toilet 16 inches minimum to 18 inches maximum from the side wall or partition?

If No, how far are the centerlines from the wall or partition?

M: \_\_\_\_\_ W: \_\_\_\_\_

Yes

No

Yes

No

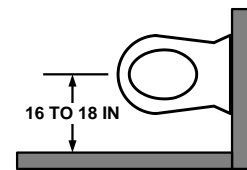
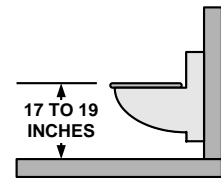

### 11. Grab Bars

Are two grab bars provided that include a 42 inch long bar on the side wall and a 36 inch long bar on the back wall (behind the toilet) and mounted at 33 to 36 inches above the floor?

If No, what are the lengths and mounting heights of the grab bars?

Side wall grab bar lengths M: \_\_\_\_\_ W: \_\_\_\_\_

Back wall grab bar lengths M: \_\_\_\_\_ W: \_\_\_\_\_

Mounting heights of grab bars M: \_\_\_\_\_ W: \_\_\_\_\_

Is the space between the wall and each grab bar 1 1/2 inches?

If No, what is the space between the walls and grab bars? M: \_\_\_\_\_ W: \_\_\_\_\_

Is each grab bar mounted securely to the wall or partition?

Yes

No

Yes

No

Yes

No

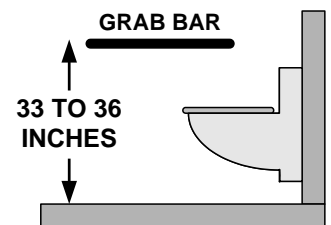
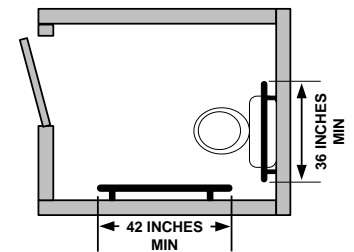

### 12. Flush Controls

Are the flush controls on the OPEN side of the transfer area and mounted no higher than 48 inches above the floor?

If No, at what height are they mounted?

M: \_\_\_\_\_ W: \_\_\_\_\_

Are flush controls operable with one hand, not requiring tight grasping, or more than 5 lbs of force?

Yes

No

Yes

No

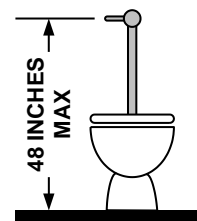

### 13. Dispensers in Toilet Stall

Are seat cover dispensers located no higher than 48 inches?

Do toilet paper dispensers provide a continuous flow of paper and are they installed at least 15 inches above the floor?

...and at a distance between 7 and 9 inches from the front edge of the toilet to the center of the dispenser?

If located ABOVE grab bar, is dispenser at least 12 inches maximum and 6 inches minimum above bar?

Yes

No

Yes

No

Yes

No

Yes

No

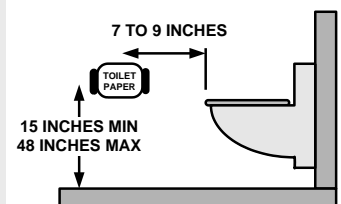

**Note:** The dispenser should not interfere with a person who needs to stand and hold the grab bar.



## Priority 4: PUBLIC RESTROOMS

***If you have single-user restrooms without a stall, skip to Item 18 for single-user restrooms.***

***If you have multiple- or single-user restrooms with stalls at least one must be accessible and meet the requirements in Items 14 - 17.***

### 14. Stall Door

Do the accessible stalls have a clear opening of 32 inches and sufficient maneuvering clearance in front of and to the side of the latch? (See Priority 2, Item 9 on page 7)

If No, what is the width? M: \_\_\_\_\_  
W: \_\_\_\_\_

Does stall door swing outward?

**Note:** For wheelchair accessible toilet stalls at the end of a row, the door may swing inward as long as sufficient maneuvering space is provided inside the stall.

- Yes  
 No

- Yes  
 No

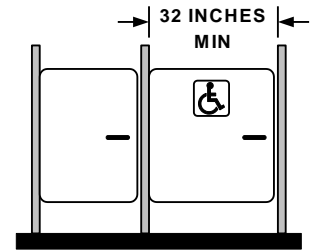

### 15. Wheelchair Accessible Stall Size

If toilet stalls are provided, at least one should be wheelchair accessible. Do the wheelchair accessible stalls provide a minimum depth of 56 inches (wall-mounted toilets) or 59 inches (floor-mounted toilets) and a width of 60 inches?

If No, what is the depth? M: \_\_\_\_\_ W: \_\_\_\_\_  
width? M: \_\_\_\_\_ W: \_\_\_\_\_

- Yes  
 No

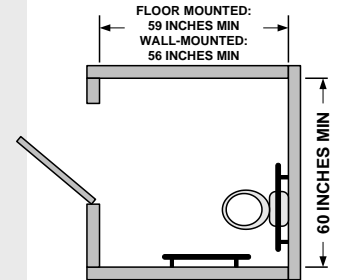

### 16. Ambulatory Accessible Toilet Compartment

Are there 6 or more stalls in the restroom?  
(or a combination of urinals and stalls totaling 6 or more?)

If yes, is at least one ambulatory stall provided?

Is the ambulatory stall 35 to 37 inches wide and 60 inches deep? If no, what are dimensions? \_\_\_\_\_

Are two grab bars provided that are 42 inches long and mounted at 33 to 36 inches above the floor?

Is the space between the wall and each grab bar 1 1/2 inches?

- Yes  
 No

- Yes  
 No

- Yes  
 No

- Yes  
 No

- Yes  
 No

**If no, skip to next item.**

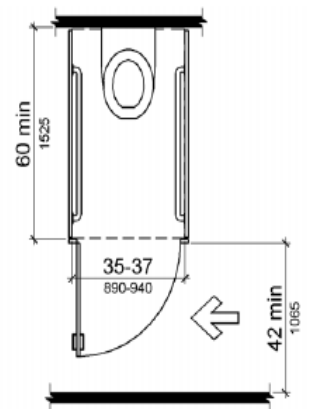

### 17. Urinals

If more than one urinal is provided, is at least one mounted so the rim is no more than 17 inches above the floor and the back of the fixture is 13 1/2 inches from the face of the rim?

- Yes  
 No  
 NAV

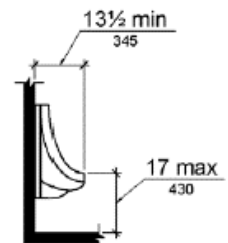

## Priority 4: PUBLIC RESTROOMS

### 18. Single-Occupant (Unisex) Toilet Rooms

Is the floor space around the toilet:

60 inches minimum measured from the side wall?

If No, what are the side wall distances?

M: \_\_\_\_\_ W: \_\_\_\_\_

56 inches minimum measured from the back wall?

If No, what are the rear wall distances?

M: \_\_\_\_\_ W: \_\_\_\_\_

*There should be no obstructions within the space around the toilet, nor should a door swing into this space.*

*Exception: If a 30 x 48 inch clear floor space and 60 inches diameter turning space is provided beyond the arc of the door swing, the door may swing inward.*

**Tip:** It is helpful to mount coat/purse hooks no higher than 48 inches in accessible stalls.

NAV

Yes

No

Yes

No

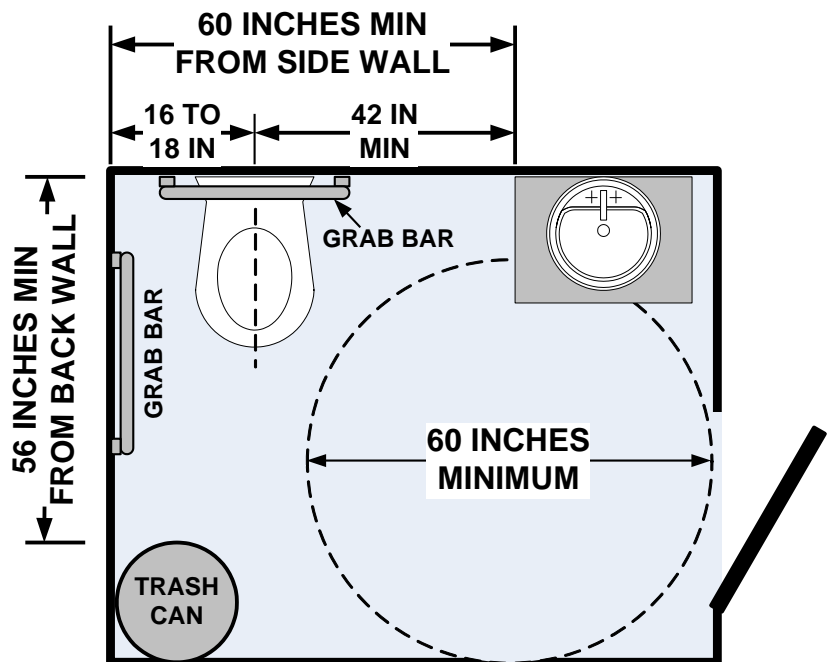
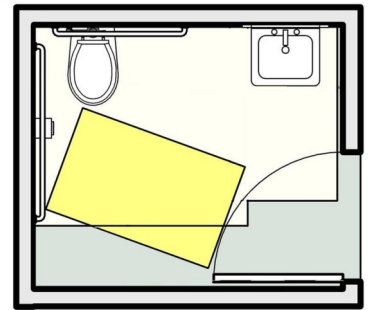
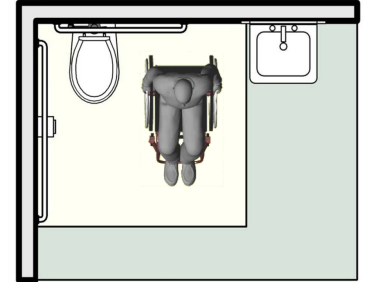

**SINGLE-OCCUPANT  
TOILET ROOM**

# HOTELS

## 1. Check In Counter

Is there an accessible portion of the counter that is no less than 36 inches long and no more than 36 inches tall?

In existing facilities, if an accessible counter is not provided, is an auxiliary counter or table available in close proximity that meets the above requirements?

- Yes
- No
- NAV
- Yes
- No
- NAV

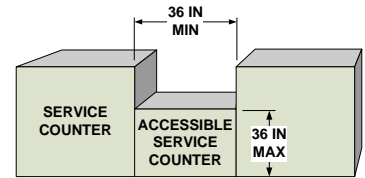

## 2. Number of Accessible Rooms and Roll-In Showers

Are accessible guest rooms available, including those with roll-in showers, that comply with the table below?

- Yes
- No



Total Number Guest Rooms Provided	Minimum Number Required Rooms Without Roll-in Showers	Minimum Number Required Rooms <u>With</u> Roll-in Showers	Total Number Accessible Rooms Required
1 to 25	1	0	1
26 to 50	2	0	2
51 to 75	3	1	4
76 to 100	4	1	5
101 to 150	5	2	7
151 to 200	6	2	8
201 to 300	7	3	10
301 to 400	8	4	12
401 to 500	9	4	13
501 to 1000	2% of total	1% of total	3% of total
1001 and over	20, plus 1 for each 100, or fraction thereof, over 1000	10, plus 1 for each 100, or fraction thereof, over 1000	30, plus 2 for each 100, or fraction thereof, over 1000

\* If no, how many accessible rooms are available?  
\_\_\_\_\_

\* What is the total number of guest rooms available for the public?  
\_\_\_\_\_

## 3. Visual Alarms and Notification Devices in Rooms Designed for Guests who are Deaf or Hard of Hearing

Refer to Item 4, pg. 23 for the required number of rooms with these features.

Do these rooms have audible and visible alarms connected to the building's emergency/fire alarm system?

- Yes
- No



★ **NEW 2010 Standards effective when remodel or rooms added:**

Audible and visible alarms must be permanently installed.

Are visual notification devices that alert residents to an incoming telephone call and door bell/knock available?

- Yes
- No



# HOTELS

## 4. Guest Rooms with Communication Features

Do the number of rooms with communication features comply with the following table?

Total # of Guest Rooms Provided	Minimum # of Required Guest Rooms with Communication Features	
	1991	★ NEW 2010
2 to 25	1	2
26 to 50	2	4
51 to 75	3	7
76 to 100	4	9
101 to 150	5	12
151 to 200	6	14
201 to 300	7	17
301 to 400	8	20
401 to 500	9	22
501 to 1000	2% of total	5% of total
1001 and over	20 plus 1 for each 100 over 1000	50, plus 3 for each 100 over 1000

Is there an electrical outlet located within 48 inches of the telephone, within reach range, to facilitate the use of a TTY?

- Yes  
 No



*\* If no, how many rooms with these communication features are available?*

Communication features are referenced in Items 3 and 5 in this section.

- Yes  
 No

## 5. Accessible Telephones

Are volume-controlled telephones available for guests in rooms with communication features?

Are text telephones (TTYs) available for guests and is one TTY phone kept at front desk so guest can communicate with hotel?

- Yes  
 No  
 Yes  
 No



## 6. Dispersion

Are the guest rooms that provide mobility features and communication features dispersed among the various classes of guest rooms? (king, double queen, suite, etc)

★ **NEW 2010 Standards effective when remodel or rooms added:**

Are no more than 10% of guest rooms with mobility features used to meet the minimum number of guest rooms with communication features?

**Note:** When the minimum number of accessible guest rooms is not sufficient to allow for complete dispersion, disperse guest rooms in the following priority:  
 Room Type, Number of Beds, and Amenities

- Yes  
 No  
 Yes  
 No



Other features that allow guests with disabilities equivalent choices are room size, bed size, cost, view, etc.

# HOTELS

## 7. Room Numbers

Are room numbers raised for tactile identification and also available in Braille?

Are signs mounted so that the tactile characters are between 48 to 60 inches from the floor surface?

If No, what are the heights?

Max: \_\_\_\_\_ Min: \_\_\_\_\_

★ **NEW 2010 Standards effective when you remodel:**

Signs must be mounted so the bottom edge of the *highest* tactile characters is 60 inches max above the floor and the *lowest* tactile characters are 48 inches minimum from the floor.

- Yes
- No

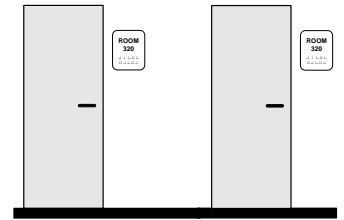

## 8. Doors

Do room entry, bathroom, and other doorways have a clear opening of 32 inches?

Are the heights of all thresholds 1/2 inch or less?

If No, what are the heights? 1. \_\_\_\_\_ 2. \_\_\_\_\_ 3. \_\_\_\_\_

**Note:** If threshold is 1/4 inch or less in height above the floor surface, no bevel is required.

- Yes
- No
- Yes
- No
- NAV

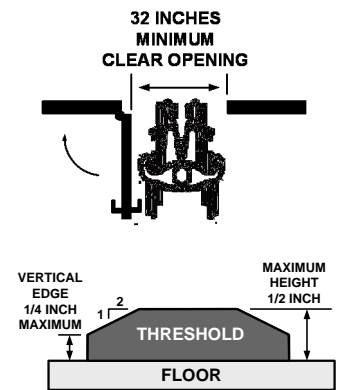

## 9. Bed Spacing and Height

Is there a minimum 30 x 48 inch clear maneuvering space on both sides of the bed in accessible rooms?

If there are two beds in the room, is there a minimum 30 x 48 inch clear floor space between the two beds?

**Note:** Recommended bed height is typically 20 to 22 inches.

- Yes
- No
- Yes
- No
- NAV

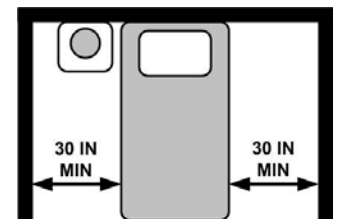

## 10. Protruding Objects

Do protruding objects such as wall mounted televisions, hanging lamps, etc. extend no more than 4 inches from wall?

- Yes
- No
- NAV

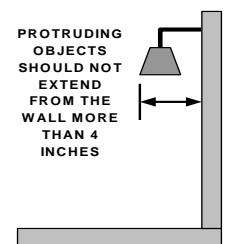

## 11. Space for Wheelchairs

Do guest rooms and bathrooms allow sufficient turning space for wheelchairs? (See Priority 3, Item 9 on page 11).

- Yes
- No



# HOTELS

## 12. Switch Access

Are light switches, heating and cooling controls, as well as curtain rods/chains (and any other similar items) located in accessible areas in the room and placed so they can be reached by a forward or parallel approach and mounted so the reachable part is no higher than 48 inches?

If No, what are the heights? 1. \_\_\_\_\_ 2. \_\_\_\_\_ 3. \_\_\_\_\_

**Note:** Approach to switches should provide clear floor space (30 x 48 inches) and be mounted between 15-48 inches high.

★ **NEW 2010 Standards no longer allows the 54 inch side approach.**

Furniture should be rearranged or removed to allow access to controls and power outlets (such as an armchair blocking the heating unit or power outlets blocked by lamps or desks).

- Yes
- No

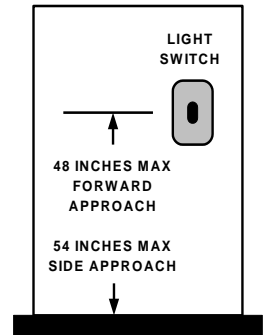

## 13. Closet Storage and Towel Racks

Are storage units mounted no higher than 48 inches?

**Note:** If shelves, cabinets, dressers or closets are provided, at least one of every type provided must be within reach.

Are towel racks mounted no higher than 48 inches?

If No, what is the height?

Towel: \_\_\_\_\_ Closet Shelf: \_\_\_\_\_ Clothes Rack \_\_\_\_\_

- Yes
- No
- Yes
- No

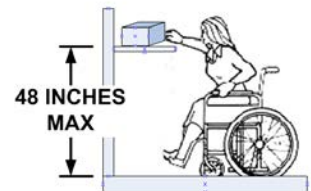

## 14. Mirrors

Are mirrors mounted so that the bottom is no higher than 40 inches above the floor?

- Yes
- No

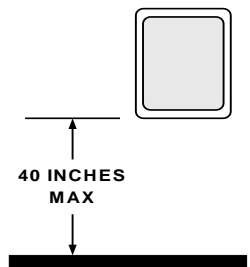

## 15. Sink Clearance

Is the sink mounted at least 27 inches from the floor to provide knee clearance, at a maximum height of 34 inches to the top surface of the sink, and is the bottom of the drain pipe at least 9 inches from the floor surface?

If No to any of the above, what are the measurements?

top surface height: \_\_\_\_\_

bottom surface height: \_\_\_\_\_

Toe clearance below pipe: \_\_\_\_\_

- Yes
- No

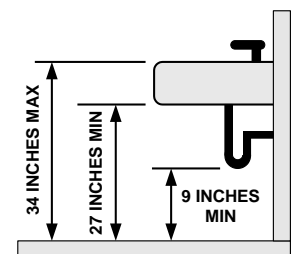

- There is no knee or toe clearance under sinks.

# HOTELS

## 16. Exposed Hot Water and Drain Pipes

Is insulation or protective covering used on drain and hot water pipes under the sink to prevent contact?

- Yes
- No
- NAV

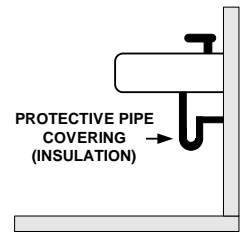

## 17. Seat Height and Distance from Wall

Is the top of the toilet 17 to 19 inches from the floor surface?

If No, how high is the toilet seat? 1. \_\_\_\_\_ 2. \_\_\_\_\_ 3. \_\_\_\_\_

- Yes
- No

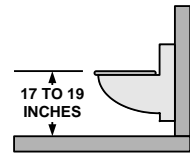

Is the centerline of the toilet 16 inches minimum to 18 inches maximum from the side wall or partition?

If No, how far are the centerlines from the wall or partition? 1. \_\_\_\_\_ 2. \_\_\_\_\_ 3. \_\_\_\_\_

- Yes
- No

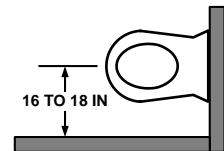

## 18. Grab Bars

Are grab bars of sufficient length and height (33 to 36 inches) mounted on the rear and side walls adjacent to the toilet?

- Yes
- No

Is the diameter of each grab bar 1-1/4 to 2 inches?

- Yes
- No

Is the space between the wall and each grab bar 1-1/2 inches?

- Yes
- No

Is each grab bar mounted securely to the wall or partition?

- Yes
- No

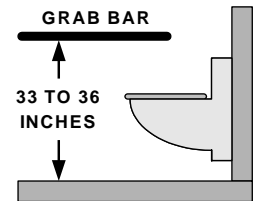

## 19. Faucet Controls

Are faucets controlled by a hand lever, push button, or electronic control which is easily operated by one hand, not requiring tight grasping, pinching, or twisting and operable with 5 pounds of force or less?

- Yes
- No

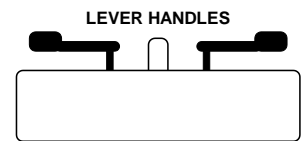

## 20. Vanity Counter Top Space

Is the counter top space in accessible guest rooms comparable in size and proximity to the sink as the counters in non-accessible rooms?

- Yes
- No

**Note:** Comparable vanity counter tops do not need to be one continuous surface or exactly the same size as counter tops in standard rooms. For example, accessible shelving could be stacked to provide usable surfaces for toiletries and other personal items.



# HOTELS

## 21. Grab Bars - Bath Tub with Removable Seat

Are there **four** grab bars of sufficient length and height mounted in the tub? See figure for location of grab bars for a bath tub having a removable seat.

If No, what are the lengths and heights of grab bars?

Length: 1. \_\_\_\_\_ 2. \_\_\_\_\_ 3. \_\_\_\_\_ 4. \_\_\_\_\_

Height: 1. \_\_\_\_\_ 2. \_\_\_\_\_ 3. \_\_\_\_\_ 4. \_\_\_\_\_

Yes

No

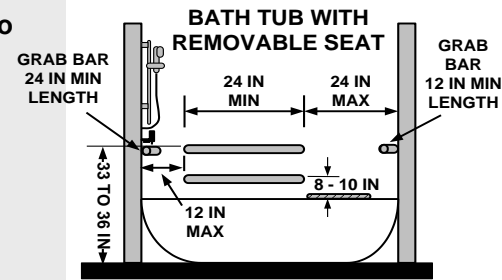

## 22. Grab Bars - Bath Tub with Permanent Seat

Are there **three** grab bars of sufficient length, height and strength mounted in the tub? See figure for location of grab bars for a bath tub having a permanent seat.

If No, what are the lengths and heights of grab bars?

Length: 1. \_\_\_\_\_ 2. \_\_\_\_\_ 3. \_\_\_\_\_

Height: 1. \_\_\_\_\_ 2. \_\_\_\_\_ 3. \_\_\_\_\_

Yes

No

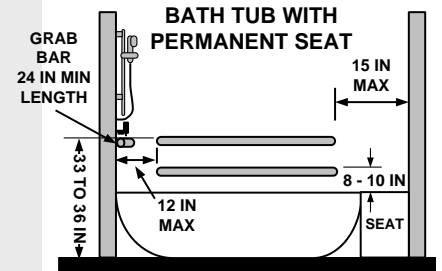

## 23. Grab Bars - For the bath tubs in Items 20 or 21:

Is the diameter of each grab bar 1-1/4 to 1-1/2 inches?

Is the space between the wall and each grab bar 1-1/2 inches?

Is each grab bar mounted firmly to the wall?

Yes

No

Yes

No

Yes

No

If No, what are the diameters and space between bar and wall?

Diameter: \_\_\_\_\_

Space: \_\_\_\_\_

## 24. Transfer Shower Stall

Is the floor space in the shower stall at least 36 x 36 inches and is a seat provided?

Is there clear floor space (48 x 36 inches) available at the open side of the shower stall?

Is there an "L-shaped" seat on the wall opposite the shower controls and does it extend the full depth of the stall?

Are horizontal grab bars installed at a height between 33 and 36 inches? See figure for location of bars.

Are controls located at a height between 38 and 48 inches above the floor?

Does the shower spray unit have a flexible hose of at least 60 inches long and can the shower head be used as both a hand-held and fixed unit?

Yes

No

NAV

Yes

No

Yes

No

Yes

No

Yes

No

Yes

No

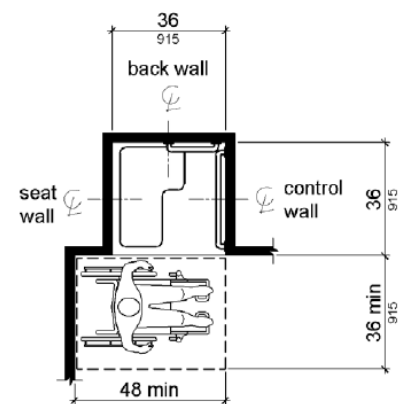

Note: inside finished dimensions measured at the center points of opposing sides

If No to any, please use the notes/sketch page to detail current dimensions and features.



# HOTELS

## 25. Roll-In Shower

If a roll-in shower is provided, does it have a minimum clear maneuvering space of 30 x 60 inches inside the shower?

For entry into the shower, is a clear floor space provided which is at least 60 inches in length and 36 inches in width adjacent to the open side?

Is a folding bench located on the side wall adjacent to the shower controls (back wall) and is it 17 minimum to 19 inches maximum above the floor?

Are grab bars installed parallel to the floor at the height between 33 and 36 inches? See figure for location of grab bars.

Are controls located on the wall adjacent to the shower seat not more than 27 inches from the wall where the seat is mounted and at a height between 38 and 48 inches above the floor?

Does the shower spray unit have a flexible hose of at least 60 inches long and can the shower head be used as both a hand-held and fixed unit?

**Note:** For roll-in showers without seats, the controls can be located on any wall. The 36 wide by 24 inch deep transfer seat with back shown in the picture is a suggested model.

**If No to any, please use the space below to detail current dimensions and features or send a picture so we can help you determine if alternative dimensions are applicable.**

Yes

No

NAV

Yes

No

Yes

No

Yes

No

Yes

No

Yes

No

Yes

No

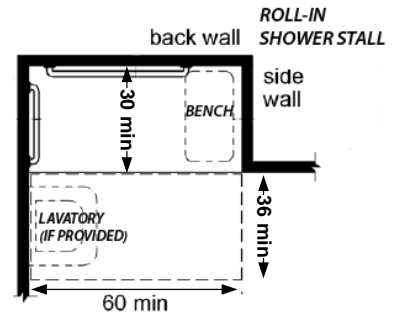

# HOTELS

**Does your hotel have conference or banquet rooms?**

Yes  No

*If No, skip to Item 31 on next page.*

## 26. Seating for People Using Wheelchairs

If tables are used in the meeting rooms, is there a 36 inch aisle clearance and a 30 inch wide space at the table for wheelchair access

- Yes  
 No

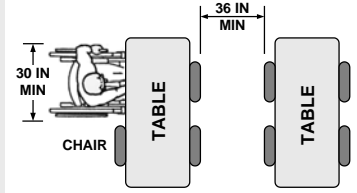

Do seating spaces at tables allow for a forward approach and provide a clear floor space of 30 by 48 inches?

- Yes  
 No

MINIMUM CLEAR FLOOR SPACE SEATING AND TABLES

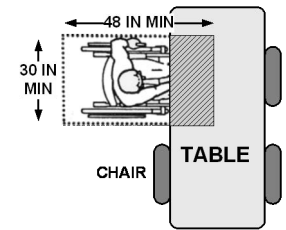

Are the spaces for people using wheelchairs dispersed throughout the room within easy viewing (line of sight) of the podium or stage?

- Yes  
 No

## 27. Table Height

Do tables have a clear opening for knee space of at least 27 inches in height, 30 inches in width, and 17 inches in depth?

- Yes  
 No

Is the top surface of the table 28 to 34 inches from floor surface?

- Yes  
 No

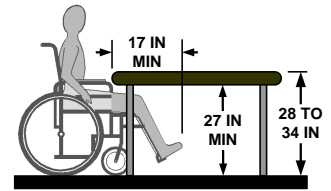

## 28. Listening System

If requested, are participants provided with an assistive listening system and can they be seated within 50 feet of the stage?

- Yes  
 No

**Note:** Listening systems are not required.

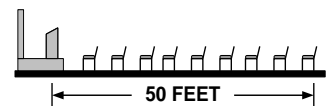

## 29. Temporary Ramp

Is a temporary ramp for the stage available?

- Yes  
 No  
 NAV

**Note:** Maximum slope of ramp is 1 inch vertical rise for every 12 inches of horizontal distance (8.3%).

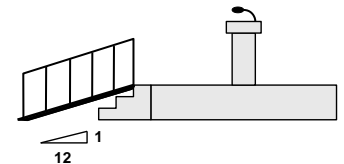

## 30. Microphones

Are the microphones accessible and flexible?

- Yes  
 No  
 NAV



# HOTELS

Does your hotel have a swimming pool?  Yes  No

If No, skip to Item 32 on pg. 31

## 31. Swimming Pool

If there is less than 300 linear feet of pool wall, is there a pool lift or sloped entry provided for entrance into pool?

- Yes
- No
- NAV

If there is more than 300 linear feet of pool wall, is there at least two means of accessible entry into the pool according to the following table:

- Yes
- No
- NAV

Permitted Means of Pool Access					
Pool Type	Sloped Entry	Lift	Transfer Wall	Transfer System	Stairs
Swimming Pool < 300 feet of pool wall ONE required	X	X			
Swimming Pool > 300 feet of pool wall TWO required	X*	X*	X	X	X
Wave action, leisure river, and other pools where entry is limited to one area	X	X		X	
Wading Pool	X				
Spa		X	X	X	

\* Primary means must be by sloped entry or lift, secondary means can be any of the permitted types.

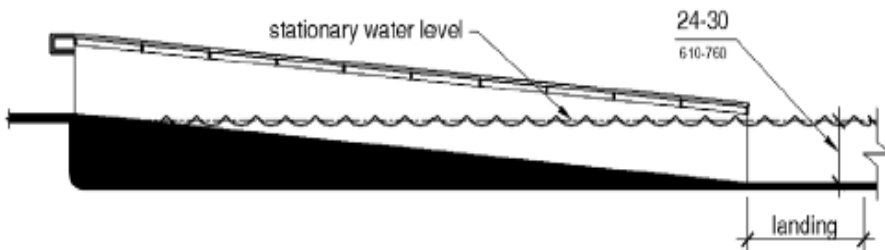

# HOTELS

**Does your hotel have a swimming pool lift available?**  
(or other accessible entry?)

Yes  No

If No, skip to Item 33

## 32. Swimming Pool Lift

Does the pool lift enter the water where the depth is less than 48 inches?

Yes

No

Is there clear deck space on the side of the pool lift that is 36 x 48 inches?

Yes

No

Is the seat height between 16 to 19 inches while in the load position?

Yes

No

Is the seat 16 inches wide?

Yes

No

Does the pool lift have foot rests?

Yes

No

Is the lift capable of unassisted operation from the deck and from the water?

Yes

No

Does the lift submerge the seat to at least 18 inches below the water?

Yes

No

Is the lift permanently installed, or if portable, can it be securely attached to the ground or side of the pool?

Yes

No

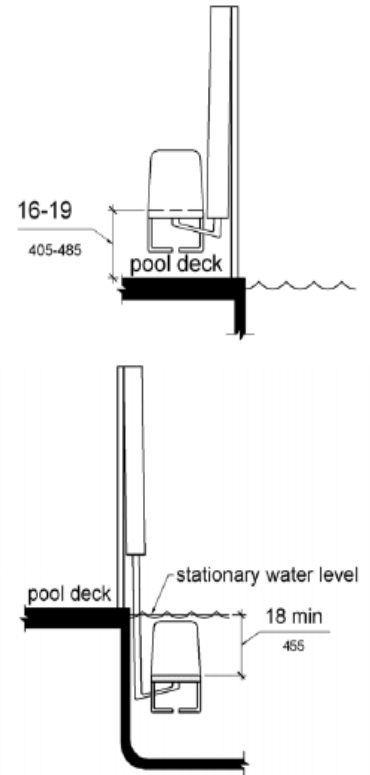

## 33. Hot Tub / Spa

Is there at least one means of entry that is a lift, transfer wall or other transfer system?

NAV

Yes

No



## 34. Sauna / Steam Rooms

Is there adequate turning space in the room and a 30 x 48 inch floor space next to the bench?

NAV

Yes

No

Is there a bench that provides back support and is it 17 to 19 inches in height?

Yes

No

Does the door swing outward so it does not impede on the clear floor space inside the room?

Yes

No



**Note:** An aquatic chair is a very helpful device used to enter pools or saunas.

# HOTELS

## 35. Accessible Route

Do hallways and corridors have a clearance of 36 inches with an occasional 5 x 5 foot space for turning and passing at intervals not exceeding 200 feet?

- Yes
- No

## 36. Clear Width of Door

Do the doors to meeting rooms, the gym, pool, sauna, laundry and other guest service areas have a clear opening of 32 inches?

- Yes
- No

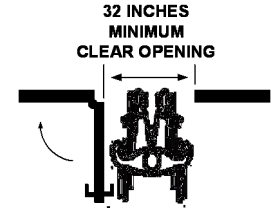

## 37. Fitness Room

Is there an accessible route 36 inches wide that leads to all exercise equipment?

- NAV
- Yes
- No

Is there clear floor space (30 x 48 inches) next to each exercise machine or equipment?

- Yes
- No

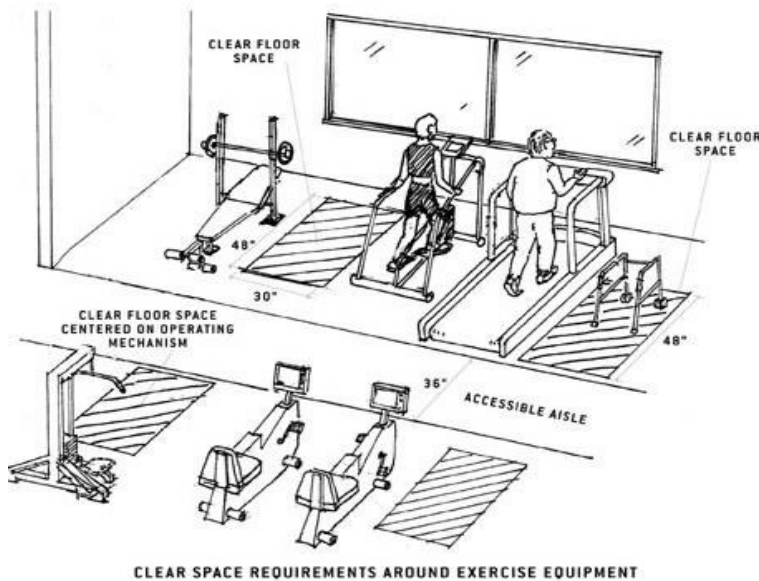

- Yes
- No



Do you provide an In-Room exercise kit?

(not required)

## 38. Washing Machines and Clothes Dryers

Do top loading machines have a door located no higher than 36 inches from the floor?

- NAV
- Yes
- No

Does the opening to front loading machines have a bottom edge that is 15 inches minimum and 36 inches maximum from the floor?

- Yes
- No

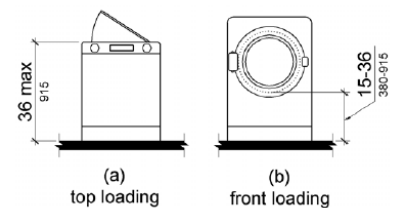

# HOTELS

**Does your hotel provide complimentary shuttle transportation?**

Yes     No

*If No, skip to Item 40*

## 39. Transportation

Is accessible transportation available upon request for guests who use wheelchair and other mobility devices without an additional charge?

**Note:** Hotel may contract with another service provider or share transportation services with another hotel with lift equipped vehicles.

- Yes  
 No



## 40. Effective Communication

Are items such as the hotel directory, room service menu, TV channel listings, and other hotel amenities provided in alternate formats such as large print, Braille, or an audio recording? (see image of small digital recorder)

Is Closed Captioning available on TVs and indicated on TV remote controls?

- Yes  
 No  
  
 Yes  
 No



## 41. Hotel Reservations

Can guest rooms with accessible features be reserved from your website?

Are the accessible and non-accessible features of each accessible guest room identified and described on your website?

- Yes  
 No  
  
 Yes  
 No

## 42. Knowledge and Training of Employees

Are staff able to describe the accessible features in each guest room, such as the specific layout of the room, shower design, communication features, and other amenities?

**As part of your commitment to accessibility, you may consider these areas of training for your staff:**

- Communicating respectfully with guests with disabilities
- How to orient a guest who is blind to their room
- Differences between mobility vs. communication features
- Housekeeping for an accessible guest room

- Yes  
 No

### Training Resources

Go to the Tools page on [www.blue-path.com](http://www.blue-path.com) for videos and info

1-800-949-4232

# RESTAURANTS in HOTELS

## 1. Seating, Tables and Food Service Counters

Do the routes around all table and seating areas, including waiting lines, have a clear opening of at least 36 inches?  
 If No, what are the widths of the clear openings?  
 \_\_\_\_\_, \_\_\_\_\_, \_\_\_\_\_, \_\_\_\_\_, \_\_\_\_\_, \_\_\_\_\_

Can chairs be spaced to provide a 30 inch wide space at the table for wheelchair access?

Do seating spaces at tables allow for a forward approach and provide a clear floor space of 30 x 48 inches?  
 If No, what are the dimensions of the spaces provided?  
 \_\_\_\_\_ x \_\_\_\_\_ / \_\_\_\_\_ x \_\_\_\_\_ / \_\_\_\_\_ x \_\_\_\_\_ / \_\_\_\_\_ x \_\_\_\_\_

Is the top surface of the dining table 28 inches minimum to 34 inches maximum height from floor surface?  
 If No, what are the table top heights? \_\_\_\_\_

Does the space under tables have leg and toe room that provides at least 27 inches in height, 30 inches in width, and 17 inches in depth?  
 If No, what are the dimensions available for leg clearance?  
 H: \_\_\_\_\_ W: \_\_\_\_\_ D: \_\_\_\_\_

Are wheelchair seating spaces distributed throughout?  
**Note:** This provides customer choice in seating location and type, reservation time or other services offered.

- Yes
- No

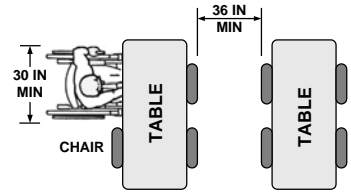

- Yes
- No

MINIMUM CLEAR FLOOR SPACE SEATING AND TABLES

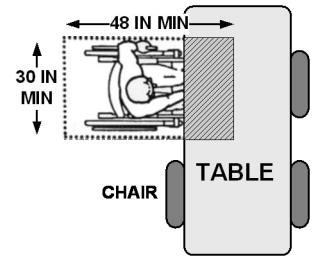

- Yes
- No

- Yes
- No

- Yes
- No

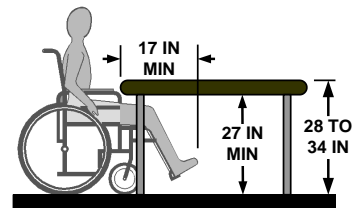

- Yes
- No

## 2. Cafeteria / Buffet Lines

Are food service lines accessible with an adjacent aisle at least 36 inches wide with adequate turning space at corners?  
 If No, what is the aisle width? \_\_\_\_\_

Is the tray slide surface mounted at a maximum height of 34 inches above the floor?  
 If No, what is the height? \_\_\_\_\_

Are food selections within 24 inches side reach (measured from the front edge of the tray slide)?

- Yes
- No
- NAV

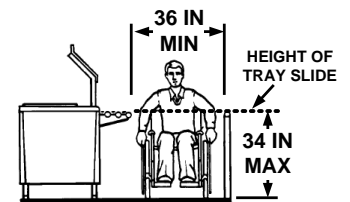

- Yes
- No

- Yes
- No

# RESTAURANTS in HOTELS

## 3. Dining Counters and Bars

Where food or drink is served at counters or bars exceeding 34 inches in height, is there a portion structurally integrated into the main counter that is a minimum of 60 inches long that provides a maximum height of 34 inches?

If no, what is the lowered height and width, if any?

H: \_\_\_\_\_ W: \_\_\_\_\_

- Yes
- No
- NAV

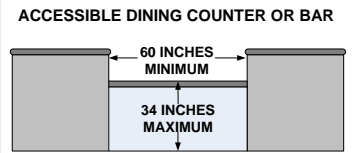

## 4. Utensil and Condiment Areas

Are 50% or more of self-service shelves and dispensing devices designed so that a person in a wheelchair can approach the shelf or device and reach the products or operable parts?

**Note:** This may require a forward or parallel approach and clear floor space (minimum 30 x 48 inches) and adequate reach range (see Item #8 in Priority 3, page 11).

- Yes
- No
- NAV

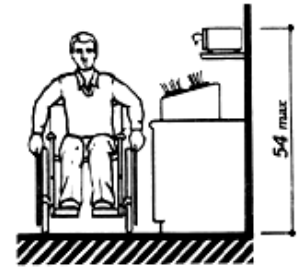

## 5. Fixed Tables

If only fixed (built-in) tables and seating are provided, are at least 5%, but not less than one fixed table, accessible?

- Yes
- No
- NAV



# RETAIL

## 1. Checkout Aisles

Are the proper number of accessible check-out aisles available and are they on an accessible route?

Total Number of Checkout Aisles	Minimum Number of Accessible Checkout Aisles
1 to 4	1
5 to 8	2
9 to 15	3
Over 15	3 plus 20% of additional aisles over 15

Are accessible checkout aisles identified by the International Symbol of Accessibility? (Not required if there is only one checkout aisle.)

Are the checkout aisles at least 36 inches wide?

If No, what are the widths? 1. \_\_\_\_\_ 2. \_\_\_\_\_ 3. \_\_\_\_\_

Are the counters in the accessible checkout aisles no higher than 38 inches above the floor?

If No, what are the heights? 1. \_\_\_\_\_ 2. \_\_\_\_\_ 3. \_\_\_\_\_

Are the tops of any raised edges of the checkout counters no higher than 40 inches above the floor?

If No, what are the heights? 1. \_\_\_\_\_ 2. \_\_\_\_\_ 3. \_\_\_\_\_

- Yes
- No
- NAV



- Yes
- No

- Yes
- No

- Yes
- No

- Yes
- No

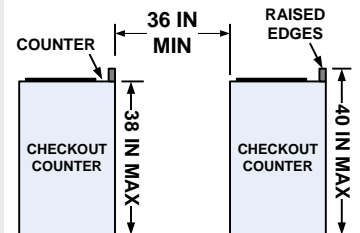

# RETAIL STORES

## 2. Service Counters

If sales and service counters or windows are provided, a portion of the counter, or at least one window, must be accessible. This includes order counters, pick-up counters, return counters, customer service counters, etc.

Are there accessible portions of service counters which are no less than 36 inches long and no more than 36 inches above the floor?

- Yes
- No
- NAV

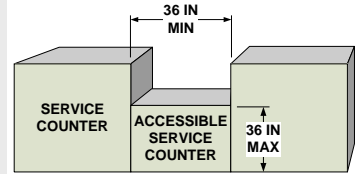

Are accessible service windows no more than 36 inches above the floor?

- Yes
- No
- NAV

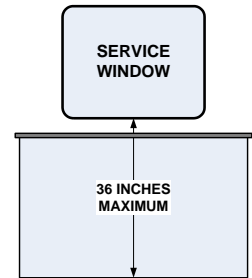

When it is not possible to provide an accessible counter, is an auxiliary counter or table available in close proximity that meets the above requirements?

- Yes
- No
- NAV

## 3. Shelves and Displays

Are self-service shelves and display units located on accessible routes and are products within reach?

**Note:** See Priority 3, Item 8 on page 11 for information on acceptable reach ranges.

- Yes
- No
- NAV



# RETAIL STORES

## 4. Dressing and Fitting Rooms

Are at least 5% (but not less than one) of dressing or fitting rooms accessible?

- Yes
- No
- NAV

Are the required accessible dressing and fitting rooms located on an accessible route?

- Yes
- No

Do all doors to accessible dressing and fitting rooms have a minimum 32 inch clear width?

- Yes
- No

Do the accessible dressing or fitting rooms provide a clear floor space at least 60 inches in diameter (a 60 x 60 inch area)?

- Yes
- No

Does every accessible dressing and fitting room have a bench that is 20 inches minimum to 24 inches maximum in depth and at least 42 inches long?

- Yes
- No

Are benches either fixed to the wall or do they have a back support?

- Yes
- No

Are bench seats 17 to 19 inches above the floor?

- Yes
- No

Is there clear floor space at least 30 x 48 inches provided alongside benches to allow a person using a wheelchair to make a parallel transfer onto the bench?

- Yes
- No

If there are mirrors, are they full-length and at least 18 inches wide by 54 inches high?

- Yes
- No
- NAV

Are the mirrors mounted in a position so that a person sitting on the bench can view themselves as well as to a person in a standing position?

- Yes
- No

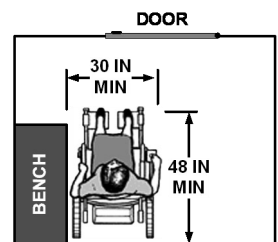
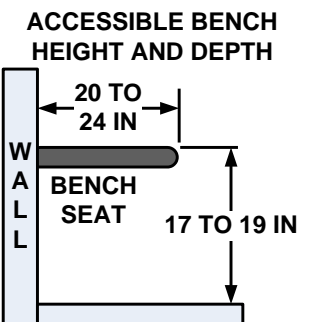
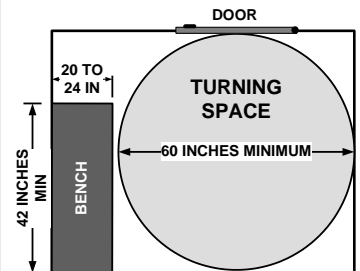
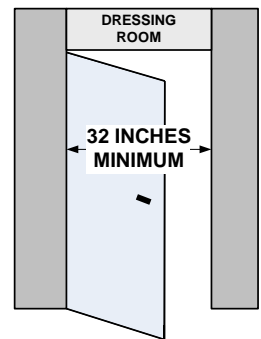

**If No to any, please use the space below to detail current dimensions and features.**

**Please use this space to write us notes or provide us with a sketch:**

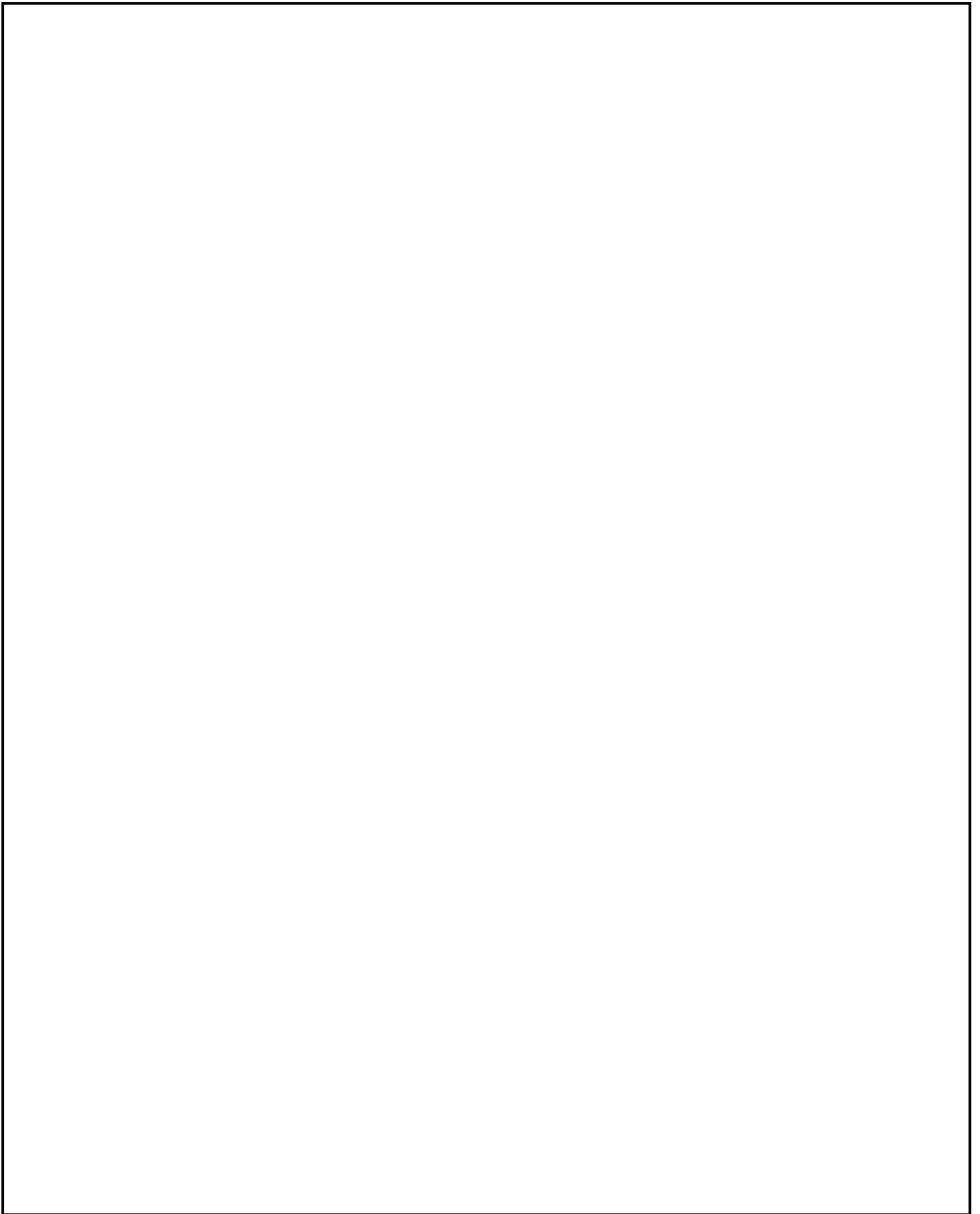
A large, empty rectangular box with a black border, intended for writing notes or providing a sketch. The box is currently blank.

## CONTACT INFORMATION

---

Name of Business: \_\_\_\_\_

Address: \_\_\_\_\_

City: \_\_\_\_\_ State: \_\_\_\_\_ Zip: \_\_\_\_\_

Do you know what year this building was constructed? \_\_\_\_\_

Name of persons performing survey:

\_\_\_\_\_ Signature: \_\_\_\_\_

\_\_\_\_\_ Signature: \_\_\_\_\_

Email: \_\_\_\_\_ Phone: \_\_\_\_\_

Date of completion: \_\_\_\_\_

How long did it take you to perform this survey? \_\_\_\_\_

Do you have suggestions about the survey design or the instructions?

\_\_\_\_\_  
\_\_\_\_\_  
\_\_\_\_\_

Do you have comments about the self-assessment process?

\_\_\_\_\_  
\_\_\_\_\_  
\_\_\_\_\_